



*An Online PDH Course  
brought to you by  
CEDengineering.com*

## **Strength Design For Reinforced Concrete Hydraulic Structures**

Course No: S03-022  
Credit: 3 PDH

---

Gilbert Gedeon, P.E.

---



Continuing Education and Development, Inc.

P: (877) 322-5800  
[info@cedengineering.com](mailto:info@cedengineering.com)

*This course was adapted from the United States Army Corps of Engineers (USACE), Publication No. EM 1110-2-2104, "Strength Design For Reinforced Concrete Hydraulic Structures", which is in the public domain.*

TABLE OF CONTENTS

	<u>Paragraph</u>	<u>Page</u>
CHAPTER 1. Introduction		
Background.....	1.1	1-1
General Requirements. ....	1.2	1-1
Scope.....	1.3	1-2
Computer Programs.....	1.4	1-2
Mandatory Requirements.....	1.5	1-2
CHAPTER 2. Details of Reinforcement		
General.....	2.1	2-1
Quality. ....	2.2	2-1
Reinforcement.....	2.3	2-1
Anchorage and Bar Development.....	2.4	2-1
Hooks and Bends. ....	2.5	2-1
Bar Spacing.....	2.6	2-1
Concrete Protection for Reinforcement.....	2.7	2-1
Splicing. ....	2.8	2-2
Temperature and Shrinkage Reinforcement .....	2.9	2-3
Concrete Materials.....	2.10	2-5
Reinforcement Detailing.....	2.11	2-5
Mandatory Requirements.....	2.12	2-7
CHAPTER 3. Strength and Serviceability Requirements		
General.....	3.1	3-1
Loads.....	3.2	3-2
Required Strength.....	3.3	3-9
Design Strength of Reinforcement. ....	3.4	3-12
Reinforcement Limits. ....	3.5	3-13
Control of Deflection and Cracking. ....	3.6	3-13

	<u>Paragraph</u>	<u>Page</u>
Minimum Thickness of Walls. ....	3.7	3-14
Mandatory Requirements.....	3.8	3-14
 CHAPTER 4. Flexure and Axial Loads		
Design Assumptions and General Requirements. ....	4.1	4-1
Interaction Diagrams. ....	4.2	4-2
Biaxial Bending and Axial Load for all Members.....	4.3	4-5
Mandatory Requirements.....	4.4	4-6
 CHAPTER 5. Shear		
Shear Strength.....	5.1	5-1
Shear Strength for Cantilevered Walls. ....	5.2	5-1
Shear Strength for Special Straight Members. ....	5.3	5-1
Shear Strength for Curved Members. ....	5.4	5-3
Mandatory Requirements.....	5.5	5-3
 APPENDICES		
APPENDIX A – References.....		A-1
APPENDIX B – Design Equations for Flexural and Axial Loads.....		B-1
APPENDIX C – Investigation Examples.....		C-1
APPENDIX D – Design Examples .....		D-1
APPENDIX E – Load Combinations for Design of Typical Reinforced Concrete Hydraulic Structures.....		E-1
APPENDIX F – Commentary on Chapter 3 .....		F-1
APPENDIX G – Acronyms and Abbreviations .....		G-1

## CHAPTER 1

### Introduction

#### 1.1. Background.

1.1.1. Industry design and construction standards (American Concrete Institute [ACI], American Association of State Highway and Transportation Officials [AASHTO], etc.) are adopted as applicable to provide safe, reliable, and cost effective hydraulic structures for civil works projects. Reinforced Concrete Hydraulic Structures (RCHS) are directly subjected to submergence, wave action, spray, icing or other severe climatic conditions, and sometimes to a chemically contaminated atmosphere. Satisfactory long-term service requires that the saturated concrete be highly resistant to deterioration due to daily or seasonal weather cycles and tidal fluctuations at coastal sites. The often relatively massive members of RCHS must have adequate density and impermeability, and must sustain minimal cracking for control of leakage and for control of corrosion of the reinforcement. Most RCHS are lightly reinforced structures (reinforcement ratios less than 1%) composed of thick walls and slabs that have limited ductility compared to the fully ductile behavior of reinforced concrete buildings (in which reinforcement ratios are typically 1% or greater).

1.1.2. Typical RCHS are: stilling basin slabs and walls; concrete lined channels; submerged features of powerhouses and pump stations; spillway piers; spray and training walls; floodwalls; submerged features of intake and outlet structures (towers, conduits and culverts); lock walls; guide and guard walls; and submerged retaining walls and other structures used for flood barriers, conveying or storing water, generating hydropower, water borne transportation, and for restoring the ecosystem.

1.1.3. This manual describes typical loads for the design of RCHS. Load factors are provided. The load factors resemble those shown in ACI 318, but are modified to account for the serviceability needs of hydraulic structures and the higher reliability needed for critical structures.

1.1.4. RCHS typically have very long service lives. A service life of 100 years is the basis for the requirements of this manual.

#### 1.2. General Requirements.

1.2.1. RCHS shall be designed with the strength design method in accordance with the ACI Standard and Report 318-14, Building Code Requirements for Structural Concrete and Commentary (ACI 318), except as specified hereinafter. The notations used are the same as those in the ACI 318, except as defined herein.

1.2.2. Design of civil works projects must be performed to ensure acceptable performance of all RCHS during and after each design event. Three levels of performance for stability, strength and stiffness are used to satisfy the structural and operational requirements for load categories with three expected ranges of recurrence (Usual, Unusual, and Extreme). Chapter 3 describes the strength and serviceability requirements for design.

1.3. Scope. This manual is written in sufficient detail to provide the designer not only with design procedures, but also with examples of their application. Also, derivations of the combined flexural and axial load equations are given to increase the designer's confidence and understanding. Chapter 2 presents general detailing requirements. Chapter 3 gives strength and serviceability requirements, including load factors and limits on flexural reinforcement. Chapter 4 includes design equations for members subjected to flexural and/or axial loads (including biaxial bending). Chapter 5 presents guidance for design for shear, including provisions for curved members and special straight members. Appendices include:

1.3.1. Appendix A: References.

1.3.2. Appendix B: Design Equations for Flexural and Axial Loads.

1.3.3. Appendix C: Investigation Examples

1.3.4. Appendix D: Design Examples.

1.3.5. Appendix E: Load Combinations for Design of Typical Reinforced Concrete Hydraulic Structures.

1.3.6. Appendix F: Commentary on Chapter 3.

1.3.7. Appendix G: Acronyms and Abbreviations.

1.4. Computer Programs. Corps library computer program CGSI (Concrete General Strength Investigation) performs general analysis of concrete members with axial and bending forces. To ensure that the design accounts for combined flexural and axial loads, any procedure that is consistent with ACI 318 guidance is acceptable as long as the load factor and reinforcement percentage guidance given in this manual is followed.

1.5. Mandatory Requirements. RCHS shall be designed in accordance with this manual.

## CHAPTER 2

### Details of Reinforcement

2.1. General. This chapter presents guidance for furnishing and placing steel reinforcement in various concrete members of hydraulic structures.

2.2. Quality. The type and grade of reinforcing steel should generally be American Society for Testing and Materials (ASTM) A 615, Grade 60. Reinforcement of other types and grades that comply with the requirements of ACI 318 and Paragraph 3.4 may be used as needed.

2.3. Reinforcement. Reinforcement is categorized as either primary or secondary reinforcement. Primary reinforcement consists of the bars required for strength. Secondary reinforcement consists of bars that serve as confining reinforcement (ties, etc.), or as reinforcement to control shrinkage or changes resulting from variations in temperature. Unless the plans and specifications specify that the primary reinforcement is to be on the outside, the width of secondary reinforcement should be subtracted when calculating effective depth of section,  $d$ .

2.4. Anchorage and Bar Development. The anchorage, bar development, and splice requirements shall conform to ACI 318 and to the requirements presented below. Since the development length is dependent on a number of factors such as concrete strength and bar position, function, size, type, spacing, and cover, the designer must indicate the length of embedment required for bar development on the contract drawings.

2.5. Hooks and Bends. Hooks and bends shall be in accordance with ACI 318. Some RCHS members can require larger bars. Detailing of bends for larger bars shall consider the width of the bars and the actual bend radii to assure proper clear spacing and concrete cover. Bends with larger bars at corners, block outs, nosing, or other changes in geometry may require additional reinforcement where large spaces outside of bend are left unreinforced.

#### 2.6. Bar Spacing.

2.6.1. Minimum Spacing. The clear distance between parallel bars shall not be less than  $1\frac{1}{2}$  times the nominal diameter of the bars nor less than  $1\frac{1}{2}$  times the maximum size of coarse aggregate. No. 14 and No. 18 bars should not be spaced closer than 6 and 8 in., respectively, center to center.

2.6.2. Maximum Spacing. To control cracking, the maximum center-to-center spacing of both primary and secondary reinforcement should not exceed 12 in.

2.7. Concrete Protection for Reinforcement. The minimum cover for reinforcement shall conform to the limits shown below for the various concrete sections. The dimensions indicate the clear distance from the edge of the reinforcement to the surface of the concrete (Table 2-1).

Table 2-1. Minimum Clear Distance from the Edge of the Reinforcement to the Surface of the Concrete.

Concrete Section	Minimum Clear Cover of Reinforcement (in.)
Unformed surfaces in contact with foundation	4
Formed or screeded surfaces subject to cavitation or abrasion erosion, such as baffle blocks and stilling basin slabs	6
Formed and screeded surfaces such as stilling basin walls, chute spillway slabs, and channel lining slabs on grade:	
Equal to or greater than 24 in. thick	4
Greater than 12 in. and less than 24 in. thick	3
Equal to or less than 12 in. thick	In accordance with ACI 318.
NOTE: In no case shall the cover be less than: 1.5 times the nominal maximum size of aggregate, or 2.5 times the maximum diameter of reinforcement.	

## 2.8. Splicing.

2.8.1. General. Bars shall be spliced only as required and splices shall be indicated on contract drawings. Splices at points of maximum tensile stress should be avoided. Where such splices must be made they should be staggered. Splices may be made by lapping of bars or butt splicing.

2.8.2. Lapped Splices. Bars larger than No. 11 shall not be lap-spliced. Tension splices should be staggered longitudinally so that no more than half of the bars are lap-spliced at any section within the required lap length. If staggering of splices is impractical, applicable provisions of ACI 318 shall be followed.

### 2.8.3. Butt Splices.

2.8.3.1. General. Bars larger than No. 11 shall be butt-spliced. Bars No. 11 or smaller should not be butt-spliced unless clearly justified by design details or economics. Due to the high costs associated with butt splicing of bars larger than No. 11, especially No. 18 bars, careful consideration should be given to alternative designs that use smaller bars. Butt splices shall be made by either welding or an approved mechanical butt-splicing method in accordance with the provisions contained in the following paragraphs and in the Unified Facilities Guide Specification (UFGS) 30 20 00.00 10.

2.8.3.2. Welded Butt Splicing. Welded splices shall be in accordance with American Welding Society (AWS) D1.4, Structural Welding Code-Reinforcing Steel. Butt splices shall develop in tension at least 125% of the specified yield strength,  $f_y$ , of the bar. Tension butt splices should be staggered longitudinally (Table 2-2).



Table 2-2. Longitudinal Stagger of Tension Butt Splices.

Bar Size	Longitudinal Stagger
≤ No. 11	ACI 318 Required Lap Length**
> No. 11	No less than 5 ft**
**No more than half of bars are spliced at any one section	

2.8.3.3. **Mechanical Butt Splicing.** Mechanical butt splicing shall be made by an approved exothermic, threaded coupling, swaged sleeve, or other positive connecting type in accordance with the current provisions of UFGS 30 20 00.00 10. The designer should be aware of the potential for slippage in mechanical splices and should insist that the testing provisions contained in this guide specification be included in the contract documents and be used in the construction work.

## 2.9. Temperature and Shrinkage Reinforcement.

2.9.1. In the design of structural members for temperature and shrinkage stresses, the area of reinforcement shall be a minimum of 0.003 times the gross cross-sectional area, half in each face, except as modified in the following paragraphs. However, past performance and/or analyses may indicate the need for an amount of reinforcement greater than this if the reinforcement is to be used for distribution of stresses as well as for temperature and shrinkage. Generally, for ease of placement, temperature and shrinkage reinforcement will be no less than No. 4 bars at 12 in. in each face. The temperature and shrinkage reinforcement will be no less than No. 4 bars at 12 in. in each face for ease of placement.

2.9.2. The area of shrinkage and temperature reinforcement need not exceed the area equivalent to No. 9 bars at 12 in. in each face. Adding more reinforcement to thick sections for control of temperature and shrinkage cracking is not effective. For thick sections, proper mix design, placement, curing, and temperature control must be used to control cracking.

2.9.3. Monolith length and control joint spacing may dictate the requirements for more shrinkage and temperature reinforcement than indicated in Paragraph 2.9.1. Good design practice can minimize cracking and control visibly wide cracks by minimizing restraint, using adequate reinforcing, and using control joints. Control joints generally include monolith joints, expansion joints, contraction joints, and construction joints. Additional considerations should be addressed when longer monolith lengths are required (road closures, pump stations, gate monoliths, long walls etc.) to provide a practical design. Table 2-3 lists minimum shrinkage and temperature reinforcement ratios for various joint spacings. Shrinkage and temperature reinforcement in the transverse (shorter) direction shall be in accordance with Paragraph 2.9.1.

Table 2-3. Minimum Shrinkage and Temperature Reinforcement Ratios for Various Joint Spacings.

Length Between Control Joints (ft)	Minimum Temperature and Shrinkage Reinforcement Ratio, Grade 60
Less than 30 ft	0.003
30-40 ft	0.004
Greater than 40 ft	0.005

2.9.4. Within a monolith, the use of contraction joints is an effective method for crack control; consideration for more shrinkage and temperature reinforcement should be weighed against the use of contraction joints. A balance between additional shrinkage and temperature reinforcement and contraction joint spacing is left to the engineer’s discretion. In general, the use of fewer contraction joints with slight increases in shrinkage and temperature reinforcement provides a more practical design with good service performance.

2.9.5. For longer monoliths or concrete features, contraction joints within the monolith should be considered, and if used, should be spaced no more than 1 to 3 times the height of the monolith or the feature’s transverse (shorter) dimension. Typically, taller or wider features would tend toward the lower end of the stated range. Shorter features (8 ft and less) would tend toward the higher end of the stated range. For example, a 24-ft high wall could have 24-ft monoliths and no contraction joints requiring 0.3 % reinforcement. The same 24-ft high wall could have 48-ft monoliths with a contraction joint in the center requiring 0.3 % reinforcement. The same 48-ft monolith without the center contraction joint would require 0.5% reinforcement. An 8-ft wall could have 24-ft monoliths with no contraction joints requiring the 0.3% reinforcement.

2.9.6. In general, additional reinforcement for temperature and shrinkage will not be needed in the direction and plane of the primary tensile reinforcement when restraint is accounted for in the analyses. However, the primary reinforcement shall not be less than that required for shrinkage and temperature as determined above.

2.9.7. Many RCHS are large and meet the definition of mass concrete. Mass concrete is defined as any volume of concrete with dimensions large enough to require that measures be taken to cope with generation of heat from hydration of the cementitious materials and attendant volume change to minimize cracking. Since mass concrete generates and gradually dissipates a significant amount of heat of hydration, it goes through a series of volumetric changes due to thermal expansion and contraction as well as shrinkage. The volumetric changes combined with restraint can create sufficient stresses to create cracking in the concrete. Control of cracking in mass concrete is typically taken care of by concrete mix design, joints, and construction sequencing. However, reinforcing steel is sometimes used to control cracking. Stresses and required reinforcement are determined using nonlinear incremental structural analysis.

## 2.10. Concrete Materials.

2.10.1. Additional reduction of drying shrinkage cracking can be achieved by considerations made to the concrete mixture design. There are two main considerations within a concrete mixture design that influence the potential of drying shrinkage cracking. The first is to minimize the paste content of the mixture. This can be achieved by minimizing the total water content used within the concrete mixture, and by keeping the total coarse aggregate content of the concrete as high as possible. The second consideration is the type of aggregates used within the concrete mixture. The designer should avoid using aggregates that have high drying shrinkage properties. Materials with these properties include sandstone and greywacke, and aggregates containing excessive amounts of clay. Aggregates that generally produce concrete with lower drying shrinkage effects are: quartz, granite, feldspar, limestone, and dolomite.

2.10.2. Other factors contributing to the amount of shrinkage include: the size and shape of the concrete element, relative humidity and temperature of the ambient air, method of curing, degree of hydration, and time. If conducted properly, shrinkage can also be reduced during the curing period after the placement has been completed. Studies have shown that the amount of shrinkage can be reduced by 10 to 20% in a concrete mixture if the period of moist curing is extended beyond 7 days, 14 days if cements blended with pozzolans are used. Note: for varying the water/cementitious materials ratio (w/cm) the reduction in shrinkage will also be varied.

2.10.3. In efforts to reduce the amount of drying shrinkage within the concrete mixture design, the designer should consult with a concrete materials engineer and/or EM 1110-2-2000, to verify that the strength and durability requirements of the structure have been satisfied.

## 2.11. Reinforcement Detailing.

2.11.1. Detailing at Joints and Corners Where Bending Moment is Transferred. This section pertains to situations where a wall or beam connects to another member to form a T or L -shape, such as a wall stem connecting to the footing of a T-wall. Full moment transfer is attained by turning the hooks from the beam as shown on the left side of Figure 2-1. (Transverse reinforcement and other required reinforcement in the vertical member are not shown.)

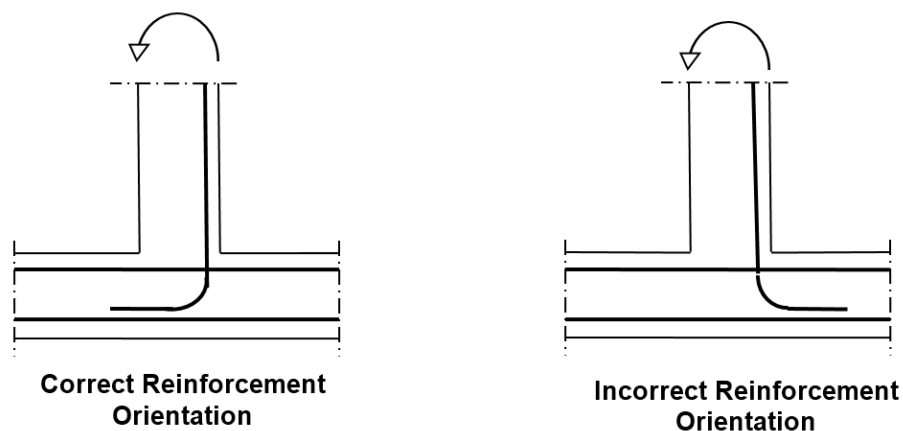

Figure 2-1. Reinforcement Detailing at Moment Connections.

### 2.11.2. Detailing for Seismic Loads.

2.11.2.1. General. Detailing of the reinforcement is very important to the performance of a structure in a seismic event. It is essential to provide confinement in the concrete in those areas where inelastic action (hinges) is anticipated. These areas are typically in locations of high moments such as: the base of culvert walls, the base of the chamber walls, or the chamber walls at points of cross-sectional discontinuities. Confinement is necessary in those areas reaching the ultimate compressive stress since these areas will be susceptible to spalling and cracking of the concrete. The confinement keeps the concrete in place forcing it to continue to carry load, even though it is severely cracked and no longer a continuum. It is important to reinforce corners in a manner that will arrest the anticipated cracks, to maintain the bond and embedment of tension and fixed piles, and to provide adequate anchorage of the reinforcement. The following paragraphs provide a general discussion of adequate details for the reinforcement.

2.11.2.2. Example of Detailing. Figure 2-2 shows an example of a pile-founded lock chamber monolith at Olmsted Locks and Dam (L&D)\* (pile foundation is not shown), which highlights the importance of seismic reinforcement details. The Olmsted L&D is located in a high seismicity region. More information on seismic details is provided in EM 1110-2-6053 and ACI 318. References to design aids that included detailing are also provided in the introduction to ACI 318-14.

- Openings. When possible, typical reinforcement of openings should include bars inclined at 45 degrees at the corners. This typical reinforcement shall be no less than that required for temperature effects. The openings shall also have adequate vertical and horizontal steel to resist the internal forces and to confine the concrete in the walls. See Figure 2-2.
- Lock walls. The base of the lock wall and the thin portions of the wall must have enough reinforcement to provide ductile behavior. The column (wall) between the chamber and the culvert could be highly susceptible to the formation of plastic hinges and should, therefore, be adequately reinforced. This requires first, that there be adequate steel to form a plastic hinge, and second, that this steel be properly anchored. The anchorage may be achieved by straight embedment or by bending the bars and running them parallel to the base slab moment reinforcement. See Figure 2-2.
- Base slab. The base slab moment reinforcement shall be tied with stirrups in regions of high moment to confine the concrete and provide a region for inelastic deformation to occur. These stirrups shall be no smaller or fewer than the reinforcement used for temperature effects.

---

\* The Olmsted L&D is currently under construction on the Ohio River, on the border between the states of Illinois and Kentucky, just east of Olmsted, IL.

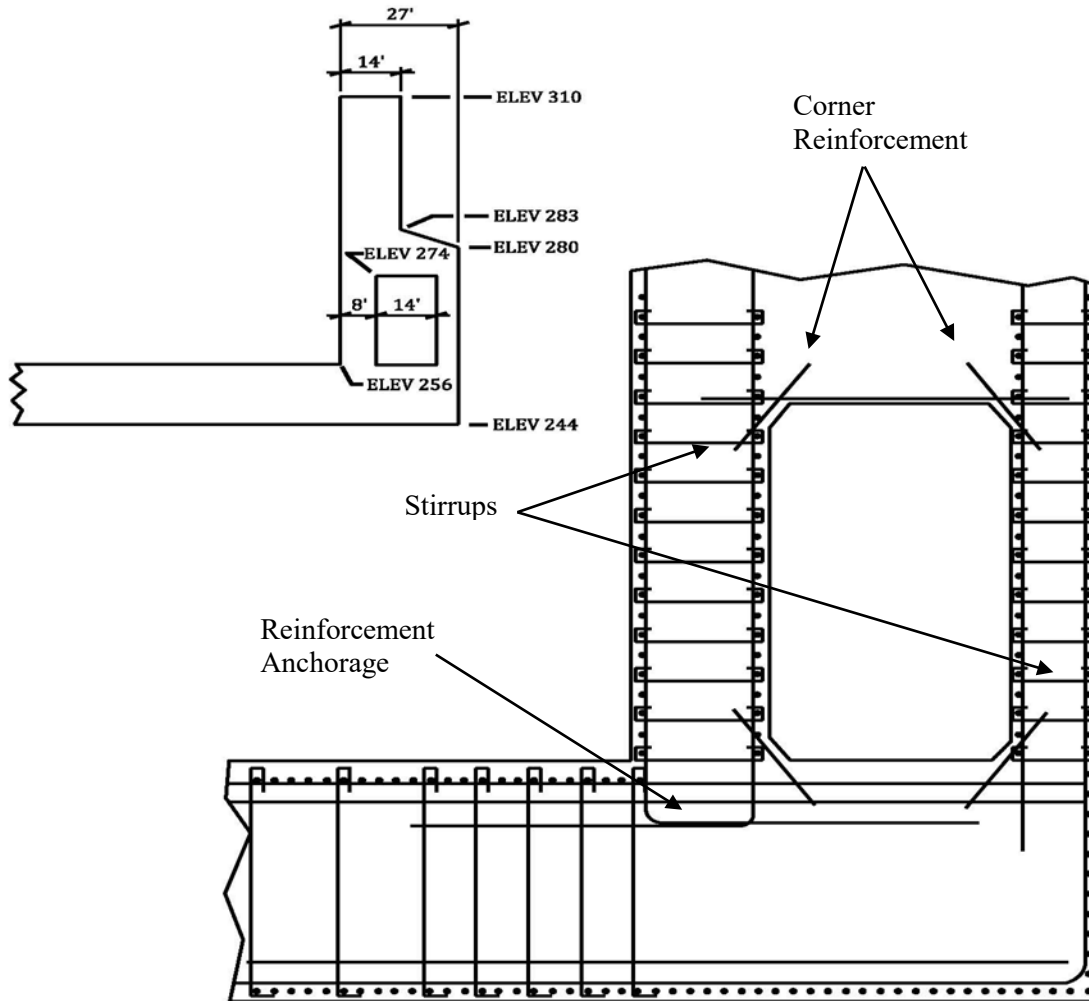

Figure 2-2. Typical Seismic Reinforcement Details – Olmsted L&D.

2.12. Mandatory Requirements.

2.12.1. Reinforcing steel materials shall meet the requirements of Paragraph 2.2.

2.12.2. Anchorage and reinforcing bar development shall meet the requirements of Paragraph 2.4.

2.12.3. Hooks and bends shall meet the requirements of Paragraph 2.5.

2.12.4. Reinforcing bar spacing shall meet the requirements of Paragraph 2.6.

2.12.5. Cover for reinforcing bars shall meet the requirements of Paragraph 2.7.

2.12.6. Splicing of reinforcing bars shall meet the requirements of Paragraph 2.8.

2.12.7. Temperature shrinkage reinforcement shall meet the requirements of Paragraph 2.9. Primary reinforcement shall be no less than that required for temperature and shrinkage.

2.12.8. When designing for seismic loads, openings shall have adequate vertical and horizontal steel to resist the internal forces and confine the concrete. Base slab reinforcement shall be tied with stirrups in regions of high moment.

## CHAPTER 3

### Strength and Serviceability Requirements

#### 3.1. General.

3.1.1. Reinforced concrete hydraulic structures (RCHS) shall be designed to satisfy all serviceability, strength, and stability requirements in accordance ACI 318 with the exceptions to the provisions of ACI 318 for load factors, load cases, and reinforcement limits contained herein.

3.1.2. Serviceability Limit States. Serviceability limit states are used for load cases that are likely to occur during the service life of the structure. The loading could be a normal event like a permanent pool or yearly high water event. It could also be an event that is infrequent, but with high likelihood of occurring during the service life of a project, such as a flood event with a return period of 100 years, which has a probability of 63% of occurring in 100 years. Service loads shall be evaluated using single load factors listed in Table 3-1 and component capacity limit states discussed in ACI 318 and Chapters 4 and 5. When combined with maximum requirements for flexural reinforcing steel ratio in Paragraph 3.5, the resulting service stresses in the concrete and reinforcing steel have been shown in past U.S. Army Corps of Engineers (USACE) RCHS design to limit cracking and provide durability for long service life.

3.1.3. Strength Limit States. Strength limit states are used for load cases that are possible, but unlikely to occur during the service life of a structure. For these cases, the nominal loads and load factors are intended to provide adequate reliability against exceeding strength limit states provided in ACI 318 and Chapters 4 and 5. Loads to be used are defined in Paragraph 3.2.2. Nominal loads will be selected to provide consistent reliability using maximum values with very low probability of exceedance.

3.1.4. Structural Stability Analysis: In addition to strength and serviceability requirements, RCHS shall also satisfy stability requirements under various loading and foundation conditions. The loads from stability and pile group analyses that are used to design structural components by the strength design method shall be obtained as prescribed in the following paragraphs to assure correctness of application. Stability analysis shall be performed in accordance with EM 1110-2-2100. Pile-founded structures shall meet the requirements of EM 1110-2-2906 for stability and design of piles.

3.1.4.1. Analyses are performed using unfactored loads to check stability failure modes described in EM 1110-2-2100 and to compute pile loads for analysis according to EM 1110-2-2906.

3.1.4.2. For strength limit state design of RCHS, equilibrium analyses are performed using factored loads to obtain factored moments, shears, and thrusts at critical sections of the RCHS.

3.1.4.3. When analyzing serviceability limit states, the unfactored loads and the resulting reactions from the stability or pile foundation analysis can be used to determine the unfactored moments, shears, and thrusts at critical sections of the RCHS structure. The unfactored moments, shears, and thrusts are then multiplied by the appropriate load factor to determine design forces used to establish the required section properties.

3.1.5. Critical and Normal Structures. RCHS, for the purpose of establishing return periods that delineate the strength load category, shall be designated as either critical or normal. A guide for classification of structures is provided in Appendix H of EM 1110-2-2100.

3.1.5.1. Critical structures are those located at high hazard potential projects the failure of which would result in probable loss of life. Loss of life could result directly from failure or indirectly from flooding damage to a lifeline facility, or could pose an irreversible threat to human life due to inundation or release of hazardous, toxic, or radioactive materials. Project hazard potential should consider the population at risk, the downstream flood depth and velocity, and the probability of fatality of individuals within the affected population.

3.1.5.2. All RCHS not meeting the definition of Critical in Paragraph 3.1.5.1 are Normal structures.

3.1.6. Hydraulic Structures Supporting Vehicles. Hydraulic structures may carry vehicle loads (including railroads and cranes) either by supporting vehicle bridge structures or by supporting vehicle loads directly such as in a culvert or the foundation of a flood closure. These structures shall be designed according to both industry guidance (AASHTO for roads or American Railway Engineering and Maintenance-of-Way Association [AREMA] for railways) and the RCHS requirements of this manual. Design according to industry guidance shall be performed with the vehicle loads as primary loads and water and other companion loads shall be applied according to industry criteria. When design is performed with RCHS loads as the primary loads, vehicle live loads shall be applied as companion loads according to Paragraph 3.2.2.

## 3.2. Loads.

3.2.1. Load Categories. For the purposes of developing performance requirements and load combinations, loads are categorized. Basic categories are based on duration and frequency.

3.2.1.1. Loads on structures vary with time. Loads can be grouped into the following categories based on duration:

- Permanent loads ( $L_p$ ), which are continuous loads such as dead load, lateral earth pressure, or a normal pool level.
- Temporary (intermittent static) loads ( $L_t$ ), which are loads with durations from several minutes to several weeks such as flood loads, maintenance dewatering, and operation live loads.
- Dynamic (impulse) loads ( $L_d$ ), which are loads with durations of seconds or less such as vessel and ice impact, earthquake, wave, and turbulent water flow. Response of RCHS structures to these loads may be dynamic, but usually is designed as static for most RCHS. Because of the short duration, it is extremely unlikely that more than one dynamic load exists at any given time; moreover, the probability of a coincidence with a peak intermittent load is negligible.

3.2.1.2. USACE design guidance uses categories of Usual, Unusual, and Extreme. Each load category has a different expected performance requirement based on the frequency of loading. The



performance goals and frequency of loading associated with the Usual, Unusual, and Extreme levels of performance are described below and are illustrated in Figure 3-1.

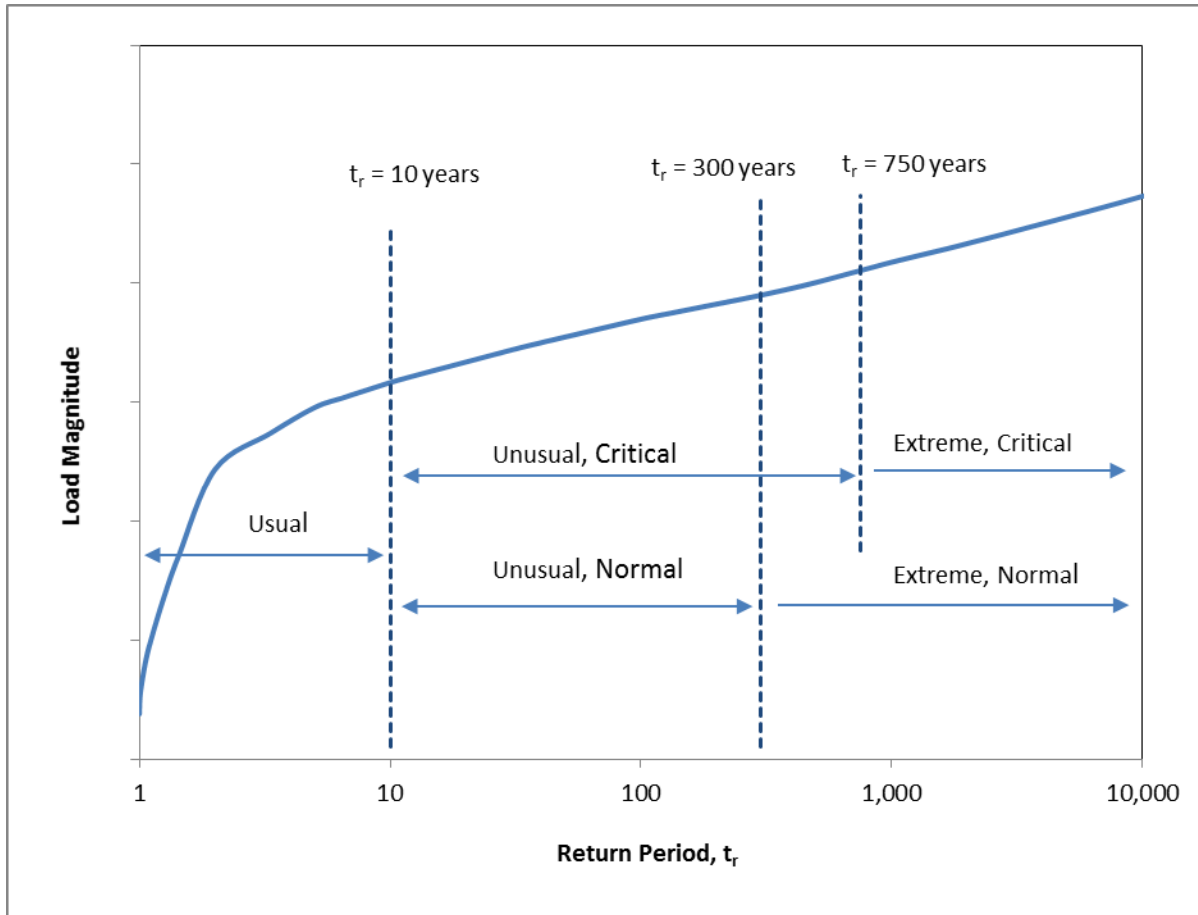

Figure 3-1. Load Category versus Return Period.

3.2.1.2.1. Usual: Usual load cases are normal, permanent, or routine operational events that are expected to have a return period (or recurrence interval) of less than or equal to 10 years (annual exceedance probability of 0.1). Permanent loads are Usual loads.

Usual Load Performance Requirements. The structural behavior of the RCHS is expected to be in the linear elastic range. Therefore, for Usual load cases, the RCHS design requirements are that: the maximum strain in the concrete does not exceed the crushing strain so the maximum strain in the reinforcement does not exceed the yield strain; and so the minimum reinforcement adequately transfers the cracking moment from the concrete to the reinforcement. Also, for Usual load cases, the serviceability limit states of the RCHS are designed so only tight, hairline cracking of concrete surfaces is barely visible and no leakage is visible. To meet these requirements, Usual loads are designed using serviceability load criteria. This is performed using ACI 318 capacity limit states, the load factors in Table 3-1, and by limiting the flexural steel to concrete ratio,  $\rho$ , to  $0.25\rho_b$  in Paragraph 3.5. With these limits, the service flexural compressive stress in the concrete will be no more than  $0.35 f'_c$  and the service flexural stress in the reinforcing steel will be less than  $0.5 f_y$ .

3.2.1.2.2. Unusual: Unusual load cases are infrequent operational events that are expected to have a return period of less than or equal to 750 years (annual exceedance probability of 0.0013) for critical structures and of less than or equal to 300 years (annual exceedance probability of 0.0033) for normal structures. Load events similar to the nominal load are likely to be experienced over the service life of the structure. Construction or maintenance events may be treated as Unusual load cases if the associated risks can be controlled by specifying the schedule, sequence, and short duration of the activities.

3.2.1.2.3. Unusual Load Performance Requirements. The structural behavior of the RCHS under Unusual loads is expected to be essentially elastic; it should sustain only minor damage. Therefore, for Unusual load cases, the design requirements for RCHS are that: the maximum strain in the concrete does not exceed the crushing strain, the maximum strain in the reinforcement remains elastic, and the minimum reinforcement adequately transfers the cracking moment from the concrete to the reinforcement. Also, for Unusual cases, the serviceability limit states of the RCHS are designed so the residual width of flexural surface cracks shall not exceed 0.004 in. and so no leakage shall be visible. To meet these requirements, Unusual loads are designed using serviceability load criteria. This is performed by using ACI 318 capacity limit states, the load factors in Table 3-1, and by limiting the maximum flexural steel to concrete ratio,  $\rho$ , to  $0.25\rho_b$  in Paragraph 3.5. With these limits, the service flexural compressive stress in the concrete will be no more than approximately  $0.4 f'_c$  and service flexural stress in the reinforcing steel will be no more than approximately  $0.55 f_y$ .

3.2.1.2.4. Extreme: Extreme load cases are rare events that are expected to have a return period of greater than 750 years (annual exceedance probability of 0.0013) for critical structures and of greater than 300 years (annual exceedance probability of 0.0033) for normal structures. Load events similar to the nominal load case are possible, but not likely over the service life of a structure. These limits set the lower bounds of design return period for use of the strength limit state and load factors. Three general conditions can be considered when designing for extreme loads:

- Extreme Load Condition 1. The maximum loading is not limited by the geometry of the structure or other physical factors and the return period of the load can be estimated. Examples are wind loads, and most wave loads. Nominal loads for design are based on return periods that provide very low probability of exceedance. Minimum return periods for selection of nominal loads are as shown below and used with a load factor of 1.0, unless stated otherwise in Paragraphs 3.2.2 and 3.3:
  - Normal Structures, Return Period, = 3,000 years
  - Critical Structures, Return Period, = 10,000 years
- Extreme Load Condition 2. The maximum loading is limited by the geometry of the structure or other physical factors and the return period of the load can be estimated. An example is a floodwall where the hydrostatic load is limited by the top of the wall. The return period of the nominal load, at the maximum possible loading, may be anywhere in the Extreme range in Figure 3-1. To provide adequate reliability a load factor of 1.3 is applied unless the load has a return period that meets the conditions of Extreme load condition 1, or unless stated otherwise in Paragraphs 3.2.2. and 3.3.

- Extreme Load Condition 3. The return period of the load is unknown. Examples are impact loads, thermal expansion of ice, operation loads, and many hydrodynamic loads. Loads for design are based on loads considered upper bound or maximum. Because of the uncertainty in the probability of these loads, a load factor of 1.3 is applied, unless stated otherwise in Paragraphs 3.2.2 and 3.3.

3.2.1.2.5. Extreme Load Performance Requirements. The structural behavior of the RCHS under Extreme loads is expected to be nonlinear; it should be expected to sustain damage, but not to collapse and cause uncontrollable flooding. Therefore, for Extreme load cases, the RCHS shall be designed for large overloads so that: the maximum strain in the concrete core does not exceed the crushing strain; the maximum strain in the reinforcement may exceed the yield strain; and the minimum reinforcement adequately transfers the cracking moment from the concrete to the reinforcement. Significant structural repairs may be required after one or more overload cycles to ensure that degradation of strength or stiffness does not result in collapse of the RCHS. To meet these requirements, Extreme load cases are designed using the strength capacity limit states in ACI 318 with load factors in Table 3-1 and flexural steel to concrete ratio,  $\rho$ , of  $0.25\rho_b$  from Paragraph 3.5.

3.2.1.3. Principal and Companion Action Loads. A load used in combination with other loads can be defined as a principal load or companion load. The maximum of combined load occurs when one load, the principal action, is at its extreme value; while the other loads, the companion actions, at the values that would be expected while the principal action is at its extreme value. Definitions are:

3.2.1.3.1. Principal Load: The specified variable load or rare load that dominates in a given load combination. Loads are selected based on probability of loading described in Paragraph 3.2.1.2.

3.2.1.3.2. Companion load: A specified variable load that accompanies the principal load in a given load combination. Companion loads are Usual loads. For Extreme load combinations, hydrostatic, temporary, and dynamic companion loads shall have a minimum return period of 10 years.

3.2.1.3.3. Principal load factor: A factor applied to the principal load in a load combination to account for the variability of the load and load pattern and the analysis of its effects.

3.2.1.3.4. Companion load factor: A factor that, when applied to a companion load in the load combination, gives the probable magnitude of a companion load acting simultaneously with the factored principal load.

3.2.2. Load Definitions. Loads used for design of RCHS are described as:

BI = Barge (or boat or vessel) impact. This is site and structure type dependent.

- Barge impact loads for serviceability load cases should be selected based on expected load frequency and performance expectations for a particular structure and site.
- Barge impact loads for strength cases are based on Extreme events. Nominal vessel impact loads shall be selected according to paragraph 3.2.1.2.4.

- Barge impact loads may be correlated with flood loads (Hs), such as for coastal walls where vessels can be blown about in storms that develop surge, and are combined with flood loads in Extreme cases when site conditions make this applicable.

D = expected value of the dead load. Dead load includes the weight of permanent structural features. Dead loads are Usual loads.

EH = Moist or effective lateral earth pressures at the site from in-situ conditions, engineered backfills, or deposition of silt during a minimum service life of 100 years. The earth pressures assumed to act on structures should be consistent with the expected movements of the structure system.

- Earth pressures for serviceability cases shall be computed according to EM 1110-2-2100.
- For the Extreme cases, driving earth pressures should be based on active pressures and resisting pressures on passive pressures, except for structures where earth pressures are at rest. A check shall be made to ensure that that factored passive pressures do not create more resisting load than driving load. If this occurs resisting pressures will be reduced to balance-factored driving loads.
- Earth pressures on culverts and pipes shall be computed according to EM 1110-2-2902.
- Earthquake-induced lateral earth pressures are defined in EM 1110-2-2100. Dynamic analysis (response spectrum or time history analysis) of earthquake should be performed using at-rest lateral earth pressures as the structure and soil can move in either direction.

EV = Vertical Earth. Weight of moist or buoyant soil on a structure.

ES = Lateral soil pressure from temporary surcharge forces. Typical surcharge forces used for design accounting for nominal vehicle or fill loading should be considered Unusual loads. Surcharge loads for the Extreme case shall be those considered to be the upper limits of possible loads.

EQ = Earthquake Load. See Paragraph 3.3.3.

G = Non-permanent gravity loads such silt, debris, and atmospheric ice. Silt and debris loads shall be based on site conditions and past experience except that a minimum of 1-in. thick layer of silt shall be assumed acting in all areas where silt can accumulate without regard to drainage features. The unit weight of silt shall be taken as 90 lbs/ft<sup>3</sup> unless site-specific data is available. Atmospheric ice loads shall be determined using guidance of ASCE 7. Other ice loads are determined based on site conditions. Gravity loads are considered Usual.

HA = Hawser forces. See EM 1110-2-2602. The design hawser force is based on the nominal breaking strength of a single line, but because of the environment, performance expectations, and load frequency shall be considered an Unusual load.

$H_s$  = Hydrostatic load. This includes lateral forces both above and below the ground line, weight of water above or in a structure, including weight of water within soil on a structure, and uplift. Hydrostatic loads may act as permanent loads, temporary loads, or a combination of both, depending on the geometry of the structure, hydrologic characteristics of the water body and operational procedures when control structures are present.

- For Usual and Unusual serviceability load cases, the designer will select the pool, differential head, groundwater level, uplift, etc. of interest for design. The load categories are defined with return period as defined in Paragraph 3.2.1.2. See Appendix E for examples. In some cases, the maximum expected head differential on a particular structure may fall in this range.
- For the Extreme design case with an return period less than the limits defined in Paragraph 3.2.1.2, and when  $H_s$  is the principal load, the design water level shall be the maximum head differential that is physically and hydrologically possible. The maximum head differential may occur after water levels have exceeded the top of a structure, before inundation on the opposite side reduces the differential head. Determination of the maximum differential head condition should be made in consultation with the project hydraulic engineers.
- When  $H_s$  is the companion load, values to be used for design shall be selected as described in Paragraph 3.2.1.3 (return period of 10 years).
- For earthquake see Paragraph 3.3.3.
- Uplift shall be calculated in accordance with EM 1110-2-2100.
- For uncertain groundwater conditions in the Extreme design case where  $H_s$  is the principal load, the design water surface is determined with hydraulic and geotechnical engineers. It shall be the ground water surface creating a maximum loading condition with extremely low probability of exceedance meeting the conditions in of paragraph 3.2.1.2.4. When insufficient probabilistic information is available, it shall be a level that creates a loading condition that can be considered an upper or lower bound, whichever has the maximum effect, based on site geometry, soils information, and water sources.

$H_d$  = Dynamic, hydrodynamic loads from thrust from vessels (propwash), downdrag, temporal head, inertial resistance, overtopping impingement, etc. Generally these loads are estimated with much uncertainty in expected values. Extreme case design values shall be based on maximum expected loading. Hydrodynamic forces from earthquakes are covered under EQ, Earthquake.

$H_w$  = Wave loads. Wave loads are computed as described in EM 1110-2-1100. Wind events used to generate wave loads must account for the location of the structure and characteristics of the hydraulic loading.

- For RCHS with waves that are independent of water levels and that are primary loads, nominal wave loads are computed for Extreme wind events according to Paragraph 3.2.1.2.4. Extreme wave loads are combined with companion hydrostatic loads,  $H_s$ .

- For other load cases with independent pool elevation and wind/wave events where wave loads are companion loads, design wave loads shall be determined as described in Paragraph 3.2.1.3 (return period of 10 years).
- For coastal situations with correlation between surge and wave, annual exceedance of combined loads must be computed using a coupled analysis. The surge level and wave force computed as a function of probability of exceedance will be provided by the hydraulic engineer.

IM = Impact from debris or floating ice. Load from floating ice impacting dam piers, the ends of lock walls, etc. is computed according to AASHTO procedures for bridge piers and is an Extreme load case. Impact from glancing blows in flow parallel to the structure or from wind driven impacts should be determined from an assessment of probable debris and past experience. Debris loads may be correlated with flood loads (Hs) and are combined with flood loads when site conditions make this applicable.

IX = Forces from thermal expansion of ice. Design values should be based on expected infrequent values for the Unusual load case and upper bound values for the Extreme load case. Thermal expansion ice forces from Usual Loads are not normally used for design.

L = Vertical live load from personnel, equipment, vehicles, or temporary storage on operating surfaces. Live load is determined and factored as described in ASCE 7.

Q = Reactions from operating equipment and hydraulic gates. Design values are based on the frequency of loading and performance expectations described in Paragraph 3.2.1.2.

T = Self straining forces from constrained structures that experience dimensional changes. Guidance for determining T is provided in ACI 318.

V = Vehicle Loads. When vehicle loads applied to RCHS are principal loads, the design shall be according to industry standards such as the AASHTO Bridge Design Specifications or AREMA Manual for Railway Engineering. When vehicle loads for RCHS are companion loads, they shall be applied to RCHS load cases and combinations according to the requirements in Paragraph 3.3.2.2. Vehicle loads applied to RCHS load cases as companion loads shall be selected from serviceability (unfactored) loads according to industry standards. They shall be considered Usual loads as described in Paragraph 3.2.1.3. RCHS supporting vehicle loads shall be designed with and without the vehicle loads present. Vehicle loads may include crane and other special loads for bridges that are used to service hydraulic structures. Designers should be aware that there are three different classification of cranes, each with different load configurations. Crane loads can be significantly greater than AASHTO design vehicle loads.

W = Wind loads shall be calculated using American Society of Civil Engineers (ASCE) Standard 7. Wind loads for critical structures shall be calculated using criteria for Risk Category IV structures if a failure from the wind load would result in consequences that meet the definition of a critical structure in Paragraph 3.1.5. Wind Loads for all other structures shall be calculated using criteria for Risk Category II structures. Wind loads included in serviceability cases shall be computed using serviceability wind loads from

ASCE 7 that meet limits of return period for Usual and Unusual described in Paragraph 3.2.1.2. Design should generally be performed using a wind velocity with a 10-year return period for Usual loads and 100-year return period for Unusual.

### 3.3. Required Strength.

3.3.1. Design Strength. The required strength computed from the effects of factored loads shall be less than the design strength, calculated as:

$$\sum \gamma_i L_{ni} \leq \phi R_n \quad (3-1)$$

where:

- $\sum \gamma_i L_{ni}$  = U = required strength, the effect of factored loads
- $\gamma_i$  = load factors that account for bias and variability in loads to which they are assigned
- $L_{ni}$  = nominal (code-specified) load effects
- $\phi$  = resistance factor from ACI 318.
- $R_n$  = nominal resistance from ACI 318 and Chapter 4.

3.3.2. Load Factors. Load factors for load and resistance factor design are as described in this section. Generic load combinations are provided. Exact load cases must be determined by the design engineer for each structure type. Examples of load cases for typical structures are shown in Appendix E.

3.3.2.1. Minimum load factors for design of RCHS are shown in Table 3-1. Consultation with and approval by CECW-CE is required for loads not covered in this table:

#### 3.3.2.2. General load combinations.

##### 3.3.2.2.1. Serviceability:

$$\text{Usual} \quad U = 2.2 [\sum L_p + \sum L_{tU} + L_{dU}] \quad (3-2)$$

$$\text{Unusual} \quad U = 1.6 [\sum L_p + L_{tNi} \text{ or } L_{dNi} + \sum L_{tU} + L_{dU}^*] \quad (3-3)$$

##### 3.3.2.2.2. Serviceability – For Members in Direct Tension:

$$\text{Usual} \quad U = 2.8 [\sum L_p + \sum L_{tU} + L_{dU}] \quad (3-4)$$

$$\text{Unusual} \quad U = 2.0 [\sum L_p + (L_{tNi} \text{ or } L_{dNi}) + \sum L_{tU} + L_{dU}^*] \quad (3-5)$$

##### 3.3.2.2.3. Strength

$$U = \sum \gamma_X L_p + (\gamma_X L_{tXi} \text{ or } \gamma_X L_{dXi}) + \sum 1.0 L_{tU} + 1.0 L_{dU}^* \quad (3-6)$$

---

\* Dynamic companion loads are not used when the principal action load is a dynamic load ( $L_{dN}$  or  $L_{dX}$ ).

3.3.2.2.4. Notes on Load Combinations:

1. Applicable loads to be combined are site specific. Examples for common structures are shown in Appendix E.
2. Lp, Lt, and Ld designate Permanent, Temporary, and Dynamic loads, respectively, as previously defined.
3. Subscripts U, N, and X designate Usual, Unusual, and Extreme load categories, respectively.
4. Loads with subscript “i” are principal action loads used individually (one at a time) in load cases.
5. Loads are combined only when it is possible for them to occur at the same time.
6. For principal action loads that are correlated, such as hydrostatic and wave forces from storm-created surge and wave, the applied principal action load need not be combined with other temporary or dynamic loads.

Table 3-1. Minimum Load Factors.

Limit State		Serviceability <sup>6</sup>		Strength
		U. Usual	N. Unusual	X. Extreme
Load Category				
Return Period, years - Critical		10	10-750	> 750
Return Period, years - Normal		10	10-300	> 300
<u>Permanent Loads, Lp</u>		$\gamma_U$	$\gamma_N$	$\gamma_X$
Dead	D	2.2 <sup>5</sup>	1.6 <sup>5</sup>	1.2 <sup>1</sup> , 0.9 <sup>2</sup>
Vertical Earth	EV	2.2 <sup>5</sup>	1.6 <sup>5</sup>	1.35 <sup>1</sup> , 1.0 <sup>2</sup>
Lateral Earth	EH	2.2 <sup>5</sup>	1.6 <sup>5</sup>	See Note 3
Hydrostatic (Companion Load)	Hs	2.2 <sup>5</sup>	1.6 <sup>5</sup>	1.0
Gravity (Mud/Ice)	G	2.2 <sup>5</sup>	1.6 <sup>5</sup>	1.6 <sup>1</sup> , 0 <sup>2</sup>
<u>Temporary Loads, Lt</u>		$\gamma_U$	$\gamma_N$	$\gamma_X$
Peak Hydrostatic - Flood, Drought, Surge, Maintenance (Principal Load)	Hs	2.2 <sup>5</sup>	1.6 <sup>5</sup>	1.0 or 1.3 <sup>4</sup>
Thermal Expansion of Ice	IX	NA	1.6 <sup>5</sup>	1.0 or 1.3 <sup>4</sup>
Soil Surcharge	ES	2.2 <sup>5</sup>	1.6 <sup>5</sup>	1.0 or 1.3 <sup>4</sup>
Operating Equipment	Q	2.2 <sup>5</sup>	1.6 <sup>5</sup>	1.0 or 1.3 <sup>4</sup>
Live Load (vertical)	L	2.2 <sup>5</sup>	1.6 <sup>5</sup>	ASCE 7 <sup>7</sup>
Self Straining	T	2.2 <sup>5</sup>	1.6 <sup>5</sup>	ACI 318 <sup>7</sup>
Vehicle Live Loads	V	2.2 <sup>5</sup>	1.6 <sup>5</sup>	AASHTO <sup>7</sup>
<u>Dynamic Loads, Ld</u>		$\gamma_U$	$\gamma_N$	$\gamma_X$
Hydrodynamic (except seismic)	Hd	2.2 <sup>5</sup>	1.6 <sup>5</sup>	1.0 or 1.3 <sup>4</sup>
Wave	Hw	2.2 <sup>5</sup>	1.6 <sup>5</sup>	1.0 or 1.3 <sup>4</sup>



Table 3-1. Minimum Load Factors (Continued).

Limit State		Serviceability <sup>6</sup>	Strength	
Debris/Floating Ice Impact	I	2.2 <sup>5</sup>	1.6 <sup>5</sup>	1.0 or 1.3 <sup>4</sup>
Barge/Boat Impact	IM	2.2 <sup>5</sup>	1.6 <sup>5</sup>	1.0 or 1.3 <sup>4</sup>
Wind	W	NA	1.6 <sup>5</sup>	ASCE 7 <sup>7</sup>
Earthquake	EQ	NA	Para 3.3.3	Para. 3.3.3
Hawser	B	NA	1.6 <sup>5</sup>	NA

Table 3-1 Notes:

1. Applied when loads add to the predominant load effect.
2. Applied when loads subtract from the predominant load effect.
3. Load Factors for Lateral Earth Pressure:
  - Structures using at-rest pressure for design
    - Driving pressure = 1.35; Resisting pressure = 0.9.
    - All other structures
      - Driving (Active) pressure = 1.5; Resisting (Passive) Pressure = 0.5
      - Dynamic analysis (response spectra and time history) of earthquake (at-rest pressure) = 1.0
4. Temporary and dynamic Extreme loads shall be designed with:
  - Load factor = 1.3
    - Loads that are physically limited with return periods lower than 3,000 years for normal structures or 10,000 years for critical structures.
    - Loads for which return period cannot be determined.
  - Load Factor = 1.0
    - Loads that are not limited, for which return period can be determined, with design with return periods greater than or equal to 3,000 years for normal structures or 10,000 years for critical structures.
5. For members in direction tension (net tension across the entire cross section): Usual load factor = 2.8, Unusual load factor = 2.0.
6. Load factors for serviceability limit states are intended to provide designs with stresses in the concrete and reinforcing steel that limit cracking under service loads. The load factors are not reliability based.
7. Where other standards are referenced, load cases and load factors from those standards will be used for design when those loads are primary loads. See load descriptions for details.

### 3.3.3. Earthquake Load (Effects).

3.3.3.1. General. Earthquake loads are considered either Unusual or Extreme due to their low probability of occurrence and duration. Yet, their low probability of occurrence also allows them to be combined with normal operating loads, such as coincidental pool, when developing load combinations. The definitions of normal/coincidental pool and earthquake-induced loads are provided in EM 1110-2-2100. Other static loads typically consist of self-weight, uplift, internal and external water pressure, and lateral soil pressures.

#### 3.3.3.2. EQ = Earthquake load.

3.3.3.2.1. In developing earthquake loads, different earthquakes are considered when designing for serviceability and strength. The Operating Basis Earthquake (OBE) is an Unusual load used for serviceability design. The Maximum Design Earthquake (MDE) is an Extreme

load used for strength design. For critical structures, MDE is the same as Maximum Credible Earthquake (MCE). The design earthquakes, ground motions, and performance requirements for the OBE, MDE, and MCE are defined in Engineer Regulation (ER) 1110-2-1806.

3.3.3.2.2. The standard seismic spectral accelerations and ground motions values can be obtained from published U.S. Geological Survey (USGS) spectral acceleration maps and USGS web based Seismic Hazard Analysis Tools. The method to develop standard response spectra and effective peak ground acceleration (EPGA) for desired return periods for OBE and MDE at the project site is described in EM 1110-2-6053.

3.3.3.2.3. The guidance with respect to site specific studies for response spectra and time histories may be found in EM 1110-2-6050 and EM 1110-2-6051, respectively.

3.3.3.3. Load combination for earthquake loads. Only one temporary load need be included at a time (if applicable) with an earthquake load.

3.3.3.3.1. For standard and site specific OBE ground motion analysis:

$$U = 1.5 (\Sigma L_p + L_{tU} + EQ) \quad (3-7)$$

3.3.3.3.2. For standard MDE ground motion analysis for Normal RCHS:

$$U = \Sigma \gamma_X L_p + 1.0 L_{tU} + 1.25 EQ \quad (3-8)$$

3.3.3.3.3. For site specific MDE ground motion analysis for Normal RCHS:

$$U = 1.0 \Sigma L_p + 1.0 L_{tU} + 1.0 EQ \quad (3-9)$$

3.3.3.3.4. For standard MCE ground motion analysis for Critical RCHS:

$$U = \Sigma \gamma_X L_p + 1.0 L_{tU} + 1.1 EQ \quad (3-10)$$

3.3.3.3.5. For site specific MCE ground motion analysis Critical RCHS:

$$U = 1.0 \Sigma L_p + 1.0 L_{tU} + 1.0 EQ \quad (3-11)$$

#### 3.4. Design Strength of Reinforcement.

3.4.1. Design should normally be based on 60,000 psi, the yield strength of ASTM Grade 60 reinforcement. Other grades may be used, subject to the provisions of Paragraphs 2.2 and 3.4.2. The yield strength used in the design shall be indicated on the drawings.

3.4.2. Reinforcement with yield strength in excess of 60,000 psi shall not be used unless a detailed investigation of ductility and serviceability requirements is conducted in consultation with and approved by CECW-CE.

### 3.5. Reinforcement Limits.

3.5.1. For a singly reinforced flexural member, or if the axial load strength ( $\phi P_n$ ) is less than the smaller of  $(0.10f_c A_g)$  or  $(\phi P_b)$ , then the ratio of tension reinforcement ( $\rho$ ) shall conform to the following requirements for all load cases.

3.5.1.1. If the tension reinforcement ratio does not exceed  $0.25\rho_b$ , then detailed analyses of the serviceability limit states are not required.

3.5.1.2. If the tension reinforcement ratio is greater than  $0.25\rho_b$ , then special detailed investigations of the serviceability limit states shall be conducted in consultation with and approved by CECW-CE. As a minimum, the special investigations of the serviceability limit states shall include estimates of the expected deflections, crack widths and spacing, and water tightness or leakage that are in substantial agreement with the results of comprehensive engineering analyses and tests or performance data.

3.5.1.3. The tension reinforcement ratio shall not exceed  $0.50 \rho_b$  to ensure that the strength limit state is a ductile failure mode.

3.5.1.4. The minimum tension reinforcement, in both the positive and negative moment regions, shall meet the following requirements:

- The minimum reinforcement ratio ( $\rho$ ) provided at every section of a flexural member shall not be less than the greater of Equations 3-12 and 3-13:

$$\rho > \frac{3.0\sqrt{f'_c}}{F_y} \quad (3-12)$$

$$\rho > \frac{200}{F_y} bd \quad (3-13)$$

Unless the reinforcement provided is at least one-third greater, at every section, then the reinforcement required by the structural analysis.

- The reinforcement must also meet the minimum requirements for temperature and shrinkage in Chapter 2.

3.5.2. Compression reinforcement shall be used in accordance with ACI 318

### 3.6. Control of Deflection and Cracking.

3.6.1. Cracking and deflections due to service loads need not be investigated if the limits on the design strength and ratio of the reinforcement specified in Paragraphs 3.4.1 and 3.5.1.3 are not exceeded. However, where RCHS connect to or support other structures or elements that may be sensitive to or damaged by movement, deflections shall be checked to ensure satisfactory performance of the system.

3.6.2. For design strengths and ratios of reinforcement exceeding the limits specified in Paragraphs 3.4 and 3.5, investigations of deformations and cracking due to service loads shall be

made in consultation with CECW-CE. These investigations should include laboratory tests of materials and models, analytical studies, special construction procedures, possible measures for crack control, etc. Deflections and crack widths should be limited to levels that will not adversely affect the operation, maintenance, performance, or appearance of a particular structure.

3.7. Minimum Thickness of Walls. Walls with height greater than 10 ft shall be a minimum of 12 in. thick. Walls 10-in. or greater in thickness shall have reinforcement in both faces. Walls shall not be less than 8 in. thick.

3.8. Mandatory Requirements.

3.8.1. RCHS shall be designed to satisfy all serviceability, strength, and stability requirements in accordance ACI 318 with the exceptions to the provisions of ACI 318 for load factors, load combinations, and reinforcement limits contained herein

3.8.2. Service loads shall be evaluated using single load factors in Table 3-1 and component capacity limit states discussed in ACI 318 and Chapters 4 and 5.

3.8.3. Stability analyses of RCHS shall be performed according to the requirements of Paragraph 3.1.4.

3.8.4. In accordance with Section 3.1.5, structures at high hazard potential projects shall be considered critical where failure will result in loss of life; all other structures will be classified as normal.

3.8.5. Hydraulic structures supporting vehicles shall be designed according to Paragraph 3.1.6.

3.8.6. The return period range limitations specified in Paragraph 3.2.1.2 shall be used to establish the correct loading condition designation. When the return for a particular loading condition cannot be established with sufficient accuracy or confidence to determine if the loading condition is Usual or Unusual (or Unusual or Extreme), the loading condition with the more stringent safety requirements shall be used.

3.8.7. Loads used for design shall conform to the definitions in Paragraph 3.2.2.

3.8.8. The required strength computed from the effects of factored loads shall be less than the capacity as defined by Equation 3-1.

3.8.9. Load Factors shall be used in accordance with Paragraph 3.3.2.1.

3.8.10. Loading conditions. As a minimum, the loading cases provided in Appendix E shall be satisfied.

3.8.11. If resistance to earthquake loads, EQ, is required, the requirements of Paragraph 3.3.3 shall be met.

3.8.12. The reinforcement ratio shall be limited by the provision of Paragraph 3.5 unless an investigation of cracking is performed as described in Paragraph 3.6.2.

3.8.13. Walls shall meet the thickness and reinforcement requirements of Paragraph 3.7.

## CHAPTER 4

### Flexure and Axial Loads

#### 4.1. Design Assumptions and General Requirements.

4.1.1. This chapter covers general design requirements for the strength design of RCHS subject to combined loadings. The general design procedure for these members is:

- Determine the member's loadings and reinforcement configuration.
- Determine the eccentricity ratio of the loading.
- Design the member using the specified  $\phi P_n$  and  $\phi M_n$  equations for the given member and eccentricity ratio.

4.1.2. Members subject to flexural and axial loads are considered in six categories:

1. Members that contain only tension reinforcement and are loaded in flexure and compression. Design of these members is covered in Section B.2.
2. Members with both tension and compression reinforcement, and are loaded in flexure and compression. Design of these members is covered in Section B.3.
3. Members loaded in tension and flexure. Design of these members is covered in Section B.4.
4. Members that support axial loadings and are subject to biaxial bending. Design of these members is covered in Paragraph 4.3.
5. Members that contain only tension reinforcement and are loaded in flexure only. Design of these members is covered in Section B.5.
6. Members that contain tension and compression reinforcement and are loaded in flexure only. Design of these members is covered in Section B.6.

4.1.3. The eccentricity of axial load ( $e'$ ) is a critical component in determining the effect that a given loading has on a member.

4.1.3.1. The eccentricity of axial load is a distance measured from the centroid of the tensile reinforcement, and is taken as:

$$e' = \frac{M_u}{P_u} + d - \frac{h}{2} \quad (4-1)$$

Where  $P_u$  is considered positive for compression and negative for tension.

4.1.3.2. For Equation 4-1, the applied moment and axial loadings are the resultants of all applied loadings. Tension loadings and moments causing the bottom of the member to act in compression are taken as negative by convention.

4.1.3.3. The eccentricity ratio normalizes eccentricities such that a ratio of one represents an axial loading acting at the member's extreme compression fiber, and a ratio of zero represents a loading acting directly at the centroid of tensile reinforcement. The eccentricity ratio for all members is defined as:

$$\frac{e'}{d} \quad (4-2)$$

4.1.4. Additional general requirements that apply to all members covered by this chapter are:

- The assumed maximum usable strain  $\epsilon_c$  at the extreme concrete compression fiber shall be equal to 0.003 in accordance with ACI 318.
- Balanced conditions for hydraulic structures exist at a cross section when the tension reinforcement  $\rho_b$  reaches the strain corresponding to its specified yield strength  $f_y$  as the concrete in compression reaches its design strain  $\epsilon_c$ . Tensile reinforcement shall be provided such that  $\rho$  complies with Section 3.5.1.
- Concrete stress of  $0.85f'_c$  shall be assumed uniformly distributed over an equivalent compression zone bounded by edges of the cross section and a straight line located parallel to the neutral axis at a distance  $a = \beta_1 c$  from the fiber of maximum compressive strain, where  $c$  is the distance from the extreme compression fiber to the neutral axis. The free body diagrams shown in Figures B-1, B-2, and B-3 illustrate these conditions.
- Factor  $\beta_1$  will be taken as specified in ACI 318.
- Factor  $k_b$  represents the ratio of stress block depth ( $a$ ) to the effective depth ( $d$ ) at balanced strain conditions. Its value can be determined for all members using:

$$k_b = \frac{\beta_1 E_s \epsilon_c}{E_s \epsilon_c + f_y} \quad (4-3)$$

4.1.5. Appendix B contains the applicable design equations for each member type described in Sections 4.1.1 through 4.1.4, along with the derivations of those equations.

## 4.2. Interaction Diagrams.

4.2.1. An interaction diagram is a plot of the axial loads and bending moments that cause a concrete member of specified size and reinforcement to fail. Figure 4-1 diagrammatically shows the compression failure, tension failure, and balance point. Figure 4-2 shows strain condition at the compression failure, tension failure and balance point.

4.2.2. Interaction diagrams can be developed using the CASE (Computer-Aided Software Engineering) computer program CGSI or commercial software. Appendix C includes an example using computer program CGSI.

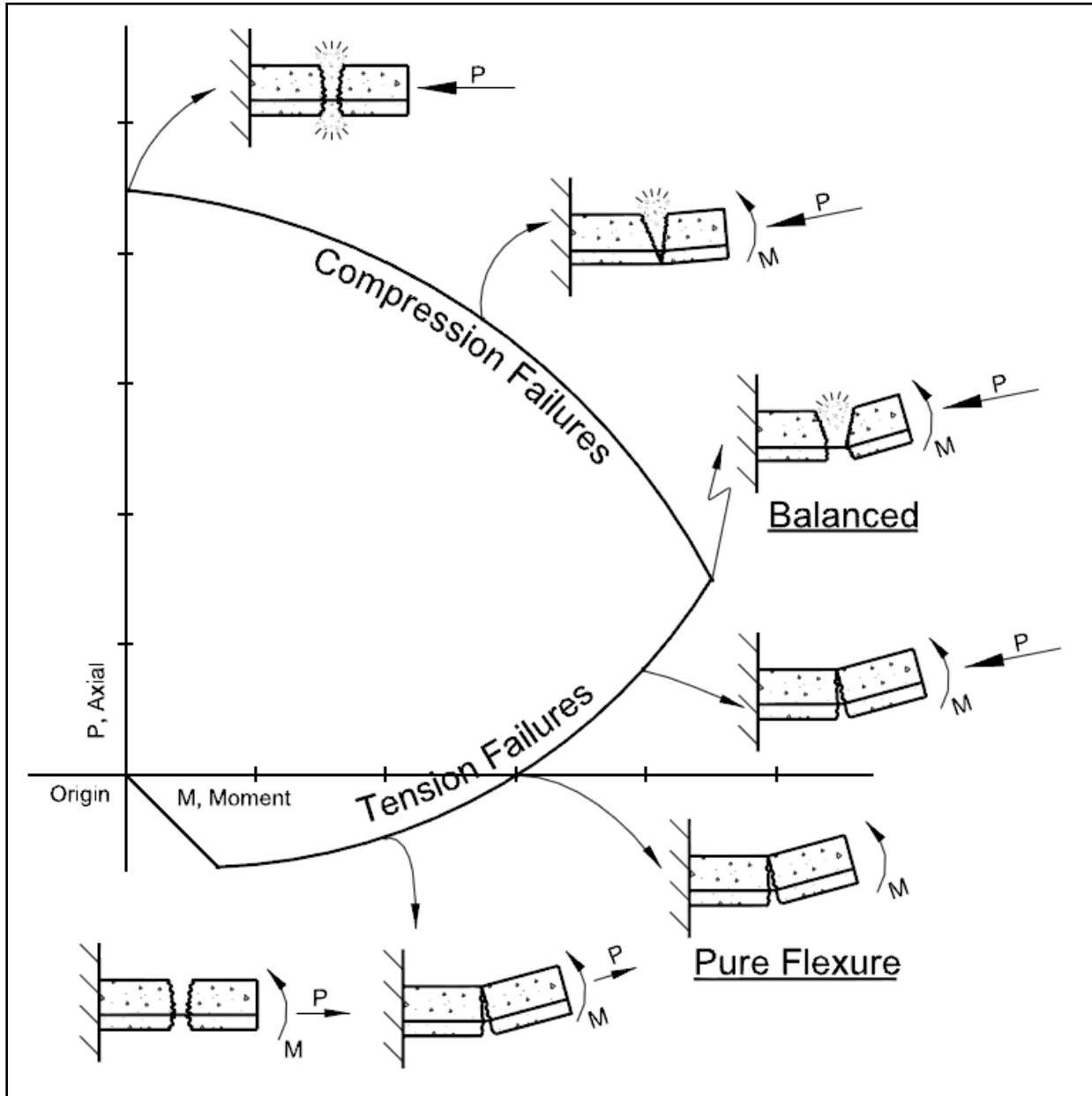

Figure 4-1. Interaction Diagram with Illustrated Failure Modes.



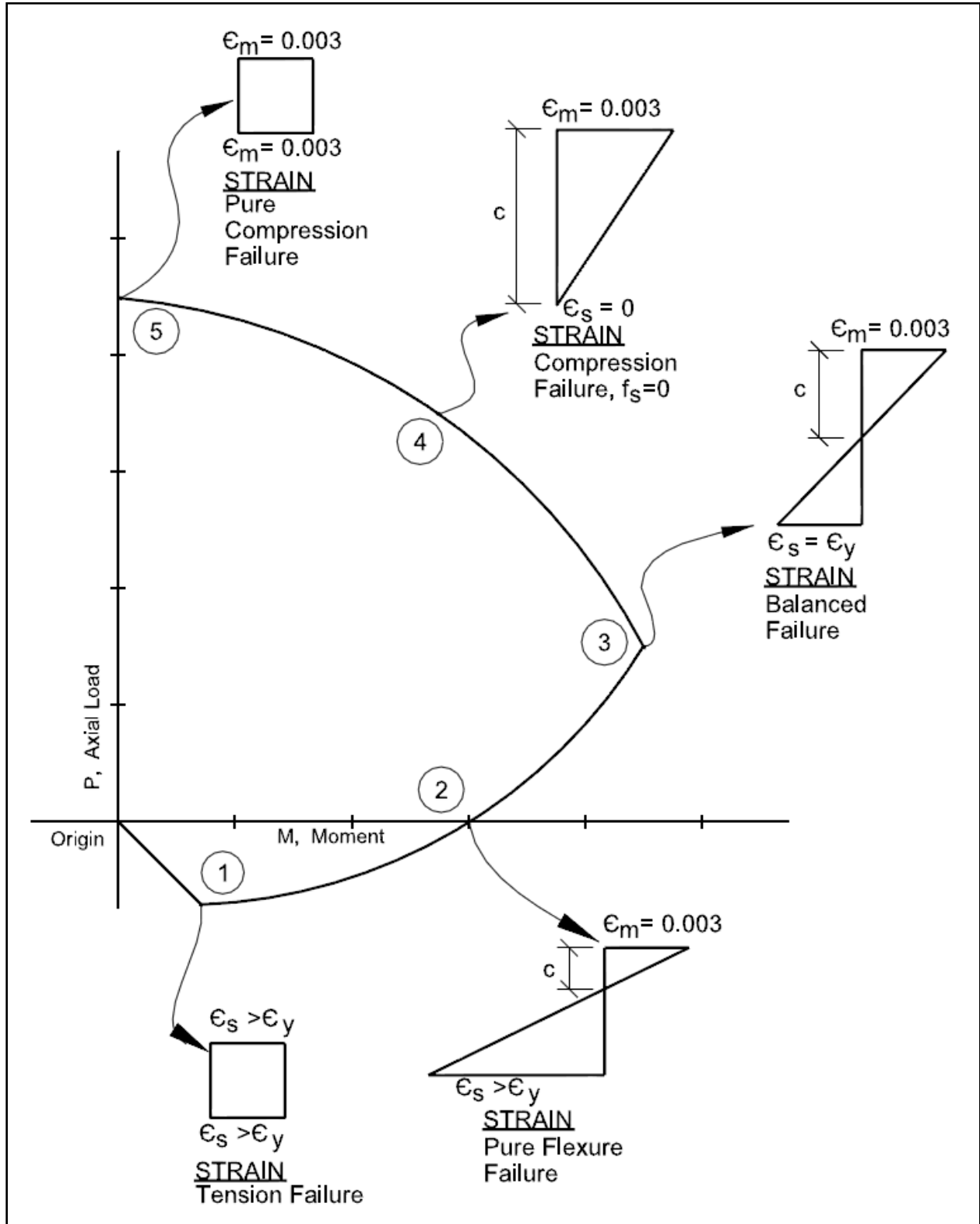

Figure 4-2. Interaction Diagram with Strain Conditions Illustrated.

4.3. Biaxial Bending and Axial Load for all Members.

4.3.1. Paragraph 4.3 applies to all reinforced concrete members subjected to biaxial bending.

4.3.2. The load contour method and equation, known as the Bresler Approach, is used for investigation or design of a square or rectangular section subjected to an axial compression in combination with bending moments about both the x and y axes. The method is described in Reinforced Concrete Design, 6<sup>th</sup> ed., by Chu-Kia Wang and Charles C. Salmon, and “Design Criteria for Reinforced Concrete Columns under Axial Load and Biaxial Loadings” ACI Journal Vol 57 No 5 Nov 1960 by Bresler. The Bresler load contour equation describing the capacity of a section with axial load and biaxial bending is:

$$\left[ \frac{M_{nx}}{M_{0x}} \right]^K + \left[ \frac{M_{ny}}{M_{0y}} \right]^K = 1.0 \quad (4-4)$$

Where:

$M_{nx}, M_{ny}$  = nominal biaxial moment strengths with respect to the x and y axes, respectively.

$M_{0x}, M_{0y}$  = uniaxial nominal bending strength at  $P_n$  about the x and y axes, respectively

For use in design, the equation is modified as shown in Equation 4-5. For a given nominal axial load  $P_n = \frac{P_u}{\phi}$ , the following nondimensional equation shall be satisfied:

$$\left[ \frac{M_{ux}}{\phi M_{0x}} \right]^K + \left[ \frac{M_{uy}}{\phi M_{0y}} \right]^K \leq 1.0 \quad (4-5)$$

Where:

$M_{ux}, M_{uy}$  = factored bending moments with respect to the x and y axes, respectively

$M_{0x}, M_{0y}$  = uniaxial nominal bending strength at  $P_n$  about the x and y axes, respectively

$M_{0x}$  = capacity at  $P_n$  when  $M_{uy}$  is zero

$M_{0y}$  = capacity at  $P_n$  when  $M_{ux}$  is zero

$K$  = 1.5 for rectangular members

= 1.75 for square or circular members.

4.3.3.  $M_{0x}$  and  $M_{0y}$  shall be determined in accordance with Paragraphs B.2 through B.4 as applicable.

4.3.4. Whenever possible, column subjected to biaxial bending should be circular in cross section. If rectangular or square columns are necessary, the reinforcement should be uniformly spread around the perimeter.

4.3.5. Appendix C includes an example of a rectangular column of axial load with biaxial bending using the computer program CGSI.

4.4. Mandatory Requirements.

4.4.1. Design of members for flexure and axial load shall meet the requirements of Paragraph 4.1.

4.4.2. Design of members for biaxial bending and axial load shall meet the requirements of Paragraph 4.3.

## CHAPTER 5

### Shear

5.1. Shear Strength. The shear strength  $V_n$  provided by concrete ( $V_c$ ) and reinforcement ( $V_s$ ) shall be computed in accordance with ACI 318 except in the cases described in Paragraphs 5.2 to 5.4. Guidance is provided in EM 1110-2-2400 (for outlet works) and EM 1110-2-6053 (for performance based design) to calculate shear capacity for seismic loads, when applicable. Some RCHS members may meet the definition of a deep beam and shall be designed according to the deep beam provisions of ACI 318.

#### 5.2. Shear Strength for Cantilevered Walls.

5.2.1. For cantilever walls, such as in T and L-Type walls, the factored shear in the wall and footing shall be less than  $\phi V_c$  unless shear reinforcement is provided. Shear reinforcement is not commonly used in walls and wall elements should be designed to eliminate the need for shear reinforcement.

5.2.2. The critical section for shear depends on the support conditions. When a construction joint is used at the base of the stem, the critical section for shear shall be taken at the base of the stem. Additionally, vertical reinforcement in both faces of the stem should be developed into the footing to ensure shear friction across the joint. The critical section for shear in the footing shall be taken at a distance,  $d$ , from the front face of the wall stem for the toe section and at the back face of the wall stem for the heel section. Figure 5-1 shows the critical sections for shear at T-wall and L-Type walls.

#### 5.3. Shear Strength for Special Straight Members.

5.3.1. The provisions of this paragraph shall apply only to straight members of box culvert sections or similar structures that satisfy the requirements of Paragraphs 5.3.1 and 5.3.2. The stiffening effects of wide supports and haunches shall be included in determining moments, shears, and member properties. The ultimate shear strength of the member is considered to be the load capacity that causes formation of the first inclined crack.

5.3.2. Members that are subjected to uniformly (or approximately uniformly) distributed loads that result in internal shear, flexure, and axial compression (but not axial tension).

5.3.3. Members having all of the following properties and construction details:

- Rectangular cross-sectional shapes.
- $\ell_n/d$  between 1.25 and 9, where  $\ell_n$  is the clear span.
- $f'_c$  not more than 6,000 psi.
- Rigid, continuous joints or corner connections.
- Straight, full-length reinforcement. Flexural reinforcement shall not be terminated even though it is no longer a theoretical requirement.

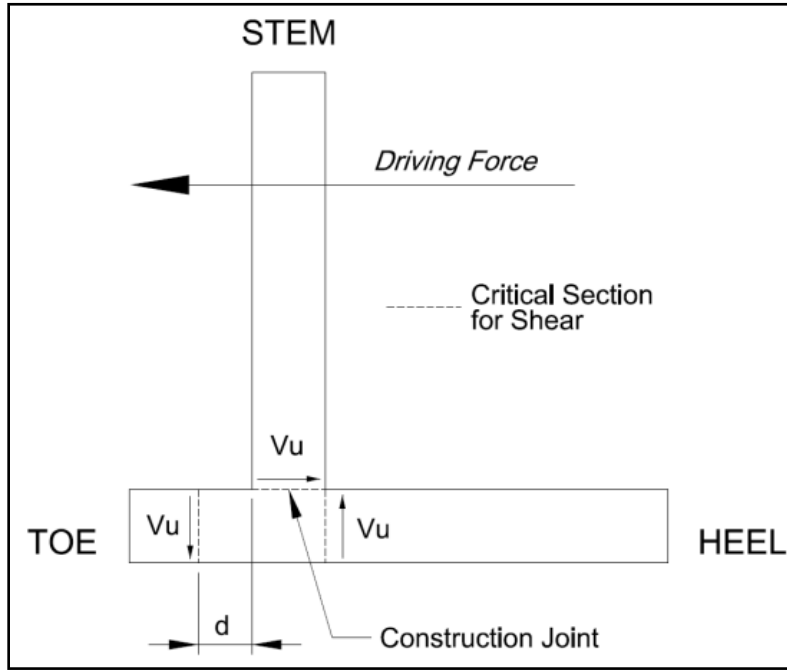

(a)

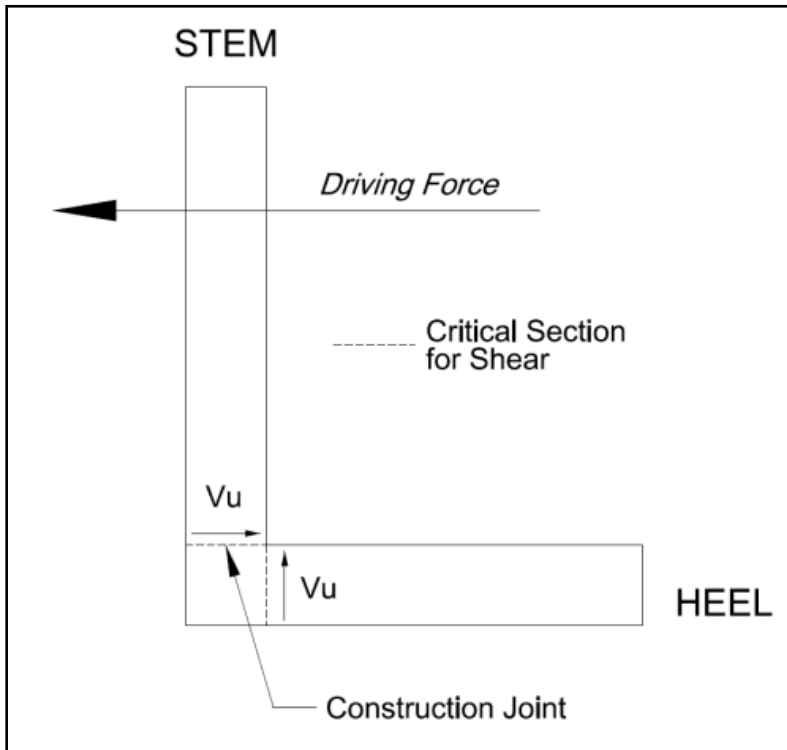

(b)

Figure 5-1. Critical Sections for Shear in Cantilever L-Type Walls.

- Extension of the exterior face reinforcement around corners such that a vertical lap splice occurs in a region of compression stress.
- Extension of the interior face reinforcement into and through the supports.

5.3.4. The shear strength provided by the concrete shall be computed as

$$V_c = \left[ \left( 11.5 - \frac{\ell_n}{d} \right) \sqrt{f'_c} \sqrt{1 + \frac{N_u/A_g}{5\sqrt{f'_c}}} \right] bd \quad (5-1)$$

at a distance of  $0.15 \ell_n$  from the face of the support.

5.3.5. The shear strength provided by the concrete shall not be taken greater than:

$$V_c = 2 \left[ 12 - \left( \frac{\ell_n}{d} \right) \right] \sqrt{f'_c} bd \quad (5-2)$$

and shall not exceed  $10 \sqrt{f'_c} bd$ .

5.4. Shear Strength for Curved Members. At points of maximum shear, for uniformly loaded curved cast-in-place members with  $R/d > 2.25$  where  $R$  is the radius curvature to the centerline of the member, the shear strength provided by the concrete shall be computed as:

$$V_c = \left[ 4\sqrt{f'_c} \sqrt{1 + \frac{N_u/A_g}{4\sqrt{f'_c}}} \right] bd \quad (5-3)$$

and shall not exceed:  $10 \sqrt{f'_c} bd$ .

5.5. Mandatory Requirements.

5.5.1. The shear strength  $V_c$  provided by concrete shall be computed in accordance with ACI 318 except in the cases described in Paragraphs 5.2 to 5.4.

5.5.2. Shear strength of cantilever walls shall meet the requirements of Paragraph 5.2.

5.5.3. Shear strength of special straight members shall meet the requirements of Paragraph 4.3.

5.5.4. Shear strength of curved members shall meet the requirements of Paragraph 4.3.

APPENDIX A

References

A.1. Required Publications.

- ER 1110-2-1806, Earthquake Design and Evaluation of Civil Works Projects. 2016
- EM 1110-2-1100, Coastal Engineering Manual, Part VI. 28 Sep 2011
- EM 1110-2-2000, Standard Practice for Concrete for Civil Works Structures. 1 Feb 1994
- EM 1110-2-2002, Evaluation and Repair of Concrete Structures. 30 Jun 1995
- EM 1110-2-2100, Stability Analysis of Concrete Structures. 1 Dec 2005
- EM 1110-2-2400, Structural Design and Evaluation of Outlet Works. 2 Jun 2003
- EM 1110-2-2602, Design of Navigation Locks. 30 Sep 1995
- EM 1110-2-2902, Conduits, Culverts, and Pipes. 31 Mar 1998
- EM 1110-2-2906, Design of Pile Foundations. 15 Jan 1991
- EM 1110-2-6050, Response Spectra and Seismic Analysis for Concrete Hydraulic Structures. 30 Jun 1999
- EM 1110-2-6051, Time-History Analysis of Concrete Hydraulic Structures. 22 Dec 2003
- EM 1110-2-6053, Earthquake Design and Evaluation of Concrete Hydraulic Structures. 1 May 2007
- American Association of State Highway and Transportation Officials (AASHTO). 2014. AASHTO LRFD Bridge Design Specification. 7<sup>th</sup> ed. Washington, DC: AASHTO.
- American Concrete Institute (ACI). 2014. Building Code Requirements and Commentary for Reinforced Concrete. ACI 318-14. Detroit, MI: ACI.
- American Concrete Institute (ACI). 2006. Environmental Engineering Concrete Structures. ACI 350-06. Detroit, MI: ACI.
- American Railway Engineering and Maintenance-of-Way Association (AREMA). 2015. 2015 Manual for Railway Engineering. Lanham, MD: AREMA.
- American Society for Testing and Materials (ASTM). 2016. Standard Specification for Deformed and Plain Billet-Steel Bars for Concrete Reinforcement. ASTM A 615-16. Philadelphia, PA: ASTM.
- American Welding Society (AWS). 2011 Structural Welding Code-Reinforcing Steel. AWS D1.4. Miami, FL: AWS.
- Bresler, B. 1960. “Design Criteria for Reinforced Concrete Columns under Axial Load and Biaxial Loadings.” ACI Journal. 57(5).
- Guide Specification 03 20 00.00 10, Civil Works Construction Guide Specification for Steel Bars, Welded Wire Fabric, and Accessories for Concrete Reinforcement.

Wang, Chu-Kia, and Charles C. Salmon. Reinforced Concrete Design. 6<sup>th</sup> ed. New York: John Wiley & Sons, Inc.

A.2. Related Publications.

EM 1110-2-1612, Ice Engineering.

EM 1110-2-2502, Retaining and Floodwalls.

EM 1110-2-2504, Sheet Pile Walls.

EM 1110-2-2607, Planning and Design of Navigation Dams.

EM 1110-2-3104, Structural and Architectural Design of Pumping Stations.

Liu, Tony C. 1980. Strength Design of Reinforced Concrete Hydraulic Structures, Report 1: Preliminary Strength Design Criteria. Technical Report SL-80-4. Vicksburg, MS: U.S. Army Engineer Waterways Experiment Station (USAWES).

Liu, Tony C., and Scott Gleason. 1981. Strength Design of Reinforced Concrete Hydraulic Structures, Report 2: Design Aids for Use in the Design and Analysis of Reinforced Concrete Hydraulic Structural Members Subjected to Combined Flexural and Axial Loads. Technical Report SL-80-4. Vicksburg, MS: USAWES.

Liu, Tony C. 1981. Strength Design of Reinforced Concrete Hydraulic Structures, Report 3: T-Wall Design. Technical Report SL-80-4. Vicksburg, MS: USAWES.

Price, W. A., M. D. Davister, and M. E. George. 1984. User's Guide for Strength Analysis of Non-Hydraulic Structural Elements, Report 1, Concrete General Strength Investigation (CGSI). Corps Program X0061, Instruction Report K-84-10, US Army Engineer Waterways Experiment Station, Vicksburg, MS.

A.3. Notation.

- $a_d$  = Depth of stress block at limiting value of balanced condition
- $b$  = Design width of member, in
- $d$  = Distance from extreme compression flange to centroid of longitudinal tension reinforcement, in
- $d_d$  = Minimum effective depth that a singly reinforced member may have and maintain steel ratio requirements
- $e'$  = Eccentricity of axial load measured from the centroid of the tension reinforcement
- $e_b'$  = Eccentricity of nominal axial load strength, at balanced strain conditions, measured from the centroid of the tension reinforcement
- $f'c$  = Specified compressive strength of concrete, psi
- $f_y$  = specified yield strength of reinforcement, psi
- $k_b$  = Ratio of stress block depth ( $a$ ) to the effective depth ( $d$ ) at balanced strain conditions
- $k_u$  = Ratio of stress block depth ( $a$ ) to the effective depth ( $d$ )
- $K$  = Exponent, equal 1.5 for rectangular members and 1.75 for square or circular members, used in nondimensional biaxial bending expression
- $l_n$  = Clear span between supports
- $M_{DS}$  = Bending moment capacity at limiting value of balanced condition



- $M_{nx}$ ,  $M_{ny}$  Nominal biaxial bending strengths with respect to the x and y axes, respectively  
 $M_{ox}$ ,  $M_{oy}$  Uniaxial nominal bending strength at  $P_n$  about the x and y axes, respectively  
 $M_{ux}$ ,  $M_{uy}$  Factored biaxial bending moments with respect to the x and y axes, respectively  
 $R$  = Radius of curvature to centerline of curved member

APPENDIX B

Design Equations for Flexural and Axial Loads

B.1. General. Design equations for each of the member types described in Section 4.1.2 are presented below, along with their derivations. The design equations provide a general procedure that may be used to design members for combined flexural and axial load.

B.2. Flexural and Compressive Capacity for Members with Tension Reinforcement Only – (Refer to Figure B-1).

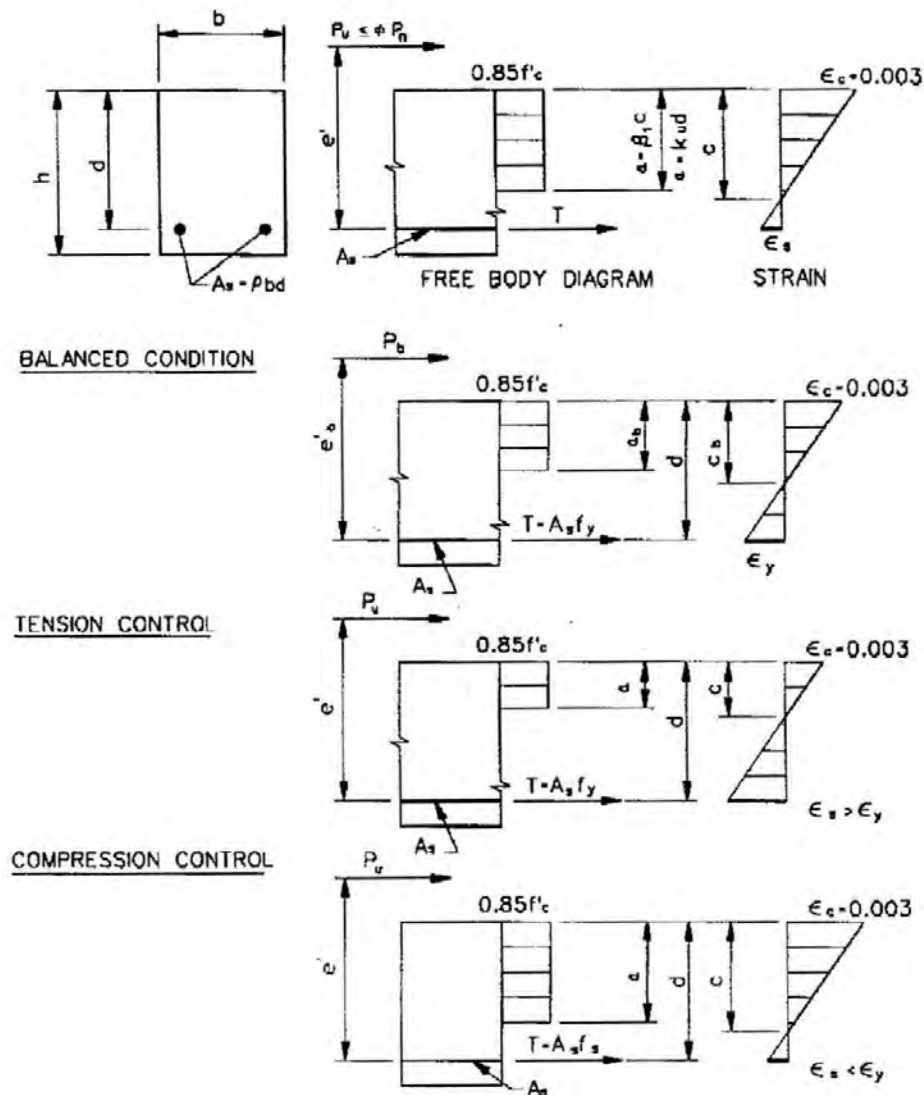

Figure B-1. Axial Compression and Flexure, Single Reinforcement.

B.2.1. For members governed by this section, the relationship between the actual eccentricity ratio and the balanced eccentricity ratio will determine whether the strength of a given section is controlled by its strength in tension or its strength in compression. The designer should determine

the member's eccentricity ratio using Equation B-7, and compare it to the balanced eccentricity ratio found using Equation B-10. If the member's eccentricity ratio is greater than the balanced eccentricity ratio, the strength of the section will be controlled by its strength in tension and the section should be designed using Section B.2.4. Otherwise, the strength of the section will be controlled by its strength in compression and should be designed using Section B.2.5.

B.2.2. Regardless of whether tension or compression controls, the design axial load strength  $\phi P_n$  for members with tie reinforcement is limited by ACI 318 and should not be greater than:

$$\phi P_{n(max)} = .8\phi[.85f'_c(A_g - \rho b d) + f_y \rho b d] \quad (B-1)$$

B.2.3. Equation B-10, which calculates the balanced eccentricity ratio of a member with flexural and compressive loadings and tension reinforcement, is derived as follows:

From equilibrium,

$$\frac{P_u}{\phi} = 0.85f'_c b k_u d - A_s f_s \quad (B-2)$$

let

$$j_u = d - \frac{a}{2} = d - \frac{k_u d}{2} \quad (B-3)$$

from moment equilibrium,

$$\frac{P_u e'}{\phi} = (0.85f'_c b k_u d)(j_u d) \quad (B-4)$$

Rewrite Equation B-4 as:

$$\begin{aligned} \frac{P_u e'}{\phi} &= (0.85f'_c b k_u d) \left( d - \frac{k_u d}{2} \right) \\ &= (0.85f'_c b d^2) \left( k_u - \frac{k_u^2}{2} \right) \\ &= 0.425f'_c (2k_u - k_u^2) b d^2 \end{aligned} \quad (B-5)$$

From the strain diagram at balanced condition (Figure B-1):

$$\begin{aligned} \frac{c_b}{d} &= \frac{\epsilon_c}{\epsilon_c + \epsilon_y} \\ \left( \frac{k_b d}{\beta_1} \right) / d &= \frac{\epsilon_c}{\epsilon_c + \epsilon_y} \end{aligned} \quad (B-6)$$

since:

$$\varepsilon_y = \frac{f_y}{E_s} ;$$

$$k_b = \frac{\beta_1 E_s \varepsilon_c}{E_s \varepsilon_c + f_y} \quad (\text{B-7})$$

since:

$$e'_b = \frac{P_b e'}{P_b} \quad (\text{B-8})$$

$e'_b$  is obtained by substituting Equations B-5 and B-2 into Equation B-8 with:

$$k_u = k_b, f_s = f_y, \text{ and } P_u = P_b.$$

$$e'_b = \frac{0.425 f'_c (2k_b - k_b^2) b d^2}{0.85 f'_c k_b b d - f_y \rho b d} \quad (\text{B-9})$$

Therefore:

$$\frac{e'_b}{d} = \frac{2k_b - k_b^2}{2k_b - \frac{f_y \rho}{0.425 f'_c}} \quad (\text{B-10})$$

**B.2.4. Design of Sections Controlled by Tension.** Members that have an eccentricity ratio higher than the balanced eccentricity ratio are controlled by their strength in tension and should be designed according to Equations B-11 and B-13. The derivations of the design equations and their relevant terms are shown below.  $\phi P_n$  is obtained from Equation B-2 with  $f_s = f_y$  as:

$$\phi P_n = \phi (0.85 f'_c b k_u d - A_s f_y)$$

$$\phi P_n = \phi (0.85 f'_c k_u - \rho f_y) b d \quad (\text{B-11})$$

The design moment  $\phi M_n$  is expressed as:

$$\phi M_n = \phi P_n e$$

$$\phi M_n = \phi P_n \left[ \frac{e'}{d} - \left( 1 - \frac{h}{2d} \right) \right] d \quad (\text{B-12})$$

Therefore,

$$\phi M_n = \phi \left( 0.85 f'_c k_u - f_y \rho \right) \left[ \frac{e'}{d} - \left( 1 - \frac{h}{2d} \right) \right] b d^2 \quad (\text{B-13})$$

Substituting Equation B-2 with  $f_s = f_y$  into Equation B-5 gives:

$$\left( 0.85 f'_c k_u b d - f_y \rho b d \right) e' = 0.425 f'_c \left( 2k_u - k_u^2 \right) b d^2 \quad (\text{B-14})$$

which reduces to:

$$k_u^2 + 2 \left( \frac{e'}{d} - 1 \right) k_u - \frac{f_y \rho e'}{0.425 f'_c d} = 0 \quad (\text{B-15})$$

Solving by the quadratic equation:

$$k_u = \sqrt{\left( \frac{e'}{d} - 1 \right)^2 + \left( \frac{\rho f_y}{0.425 f'_c} \right) \frac{e'}{d}} - \left( \frac{e'}{d} - 1 \right) \quad (\text{B-16})$$

B.2.5. Sections Controlled by Compression. Members that have an eccentricity ratio less than or equal to the balanced eccentricity ratio are controlled by their strength in compression and should be designed according to Equations B-17 and B-18 below. The derivation of the design equations and their relevant terms is shown below.  $\phi P_n$  is obtained from Equation B-2.

$$\phi P_n = \phi \left( 0.85 f'_c k_u - \rho f_s \right) b d \quad (\text{B-17})$$

and  $\phi M_n$  is obtained by multiplying Equation B-17 by  $e$ .

$$\phi M_n = \phi \left( 0.85 f'_c k_u - \rho f_s \right) \left[ \frac{e'}{d} - \left( 1 - \frac{h}{2d} \right) \right] b d^2 \quad (\text{B-18})$$

The steel stress,  $f_s$ , is expressed as  $f_s = E_s \varepsilon_s$ .

From Figure B-1:

$$\frac{c}{d} = \frac{\varepsilon_c}{\varepsilon_c + \varepsilon_s}$$

or

$$\frac{\left( \frac{k_u d}{\beta_1} \right)}{d} = \frac{\varepsilon_c}{\varepsilon_c + \varepsilon_s}$$

therefore,

$$f_s = \frac{E_s \varepsilon_c (\beta_1 - k_u)}{k_u} \quad (\geq -f_y) \quad (\text{B-19})$$

Substituting Equations B-2 and B-19 into B-5 gives

$$0.85 f'_c k_u b d e' - \left[ \frac{E_s \varepsilon_c (\beta_1 - k_u)}{k_u} \right] \rho b d e' = 0.425 f'_c (2k_u - k_u^2) b d^2 \quad (\text{B-20})$$

which can be arranged as:

$$k_u^3 + 2 \left( \frac{e'}{d} - 1 \right) k_u^2 + \left( \frac{E_s \varepsilon_c \rho e'}{0.425 f'_c d} \right) k_u - \frac{\beta_1 E_s \varepsilon_c \rho e'}{0.425 f'_c d} \quad (\text{B-21})$$

### B.3. Flexural and Compressive Capacity for Members with both Tension and Compression Reinforcement (Refer to Figure B-2).

B.3.1. For structures governed by this subchapter, the relationship of the actual eccentricity ratio to the balanced eccentricity ratio will determine whether the strength of a given section is controlled by its strength in tension or its strength in compression. The designer should determine the member's eccentricity ratio using Equation B-25, and compare it to the balanced eccentricity ratio found using Equation B-28 below. If the member's eccentricity ratio is greater than the balanced eccentricity ratio, the strength of the section will be controlled by its strength in tension and the section should be designed using Section B.3.5. Else, the strength of the section will be controlled by its strength in compression and should be designed using Section B.3.6.

B.3.2. Design for flexure using compression reinforcement is discouraged. However, if compression reinforcement is used in members controlled by compression, lateral reinforcement shall be provided in accordance with the ACI 318.

B.3.3. Regardless of whether tension or compression controls, the design axial load strength  $\phi P_n$  for sections governed by this subchapter is limited by ACI 318 and should not be taken as greater than:

$$\phi P_{n(max)} = .8\phi [0.85 f'_c (A_g - (\rho + \rho') bd) + f_y (\rho + \rho') bd] \quad (\text{B-22})$$

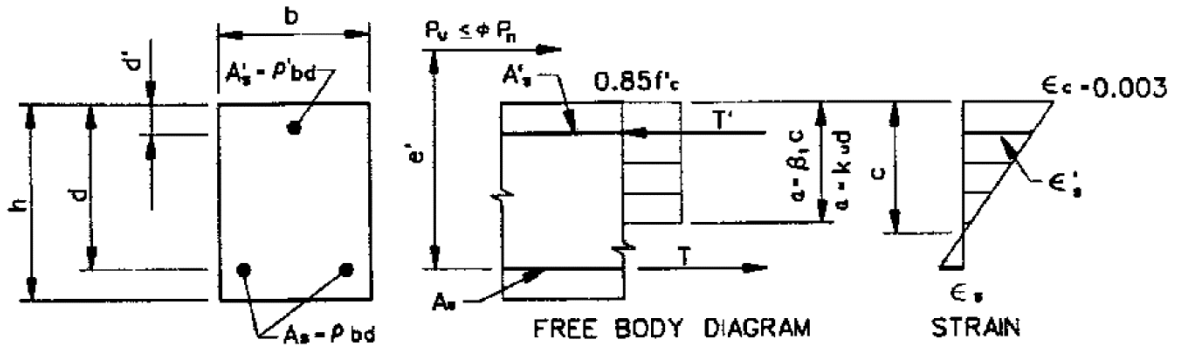

BALANCED CONDITION

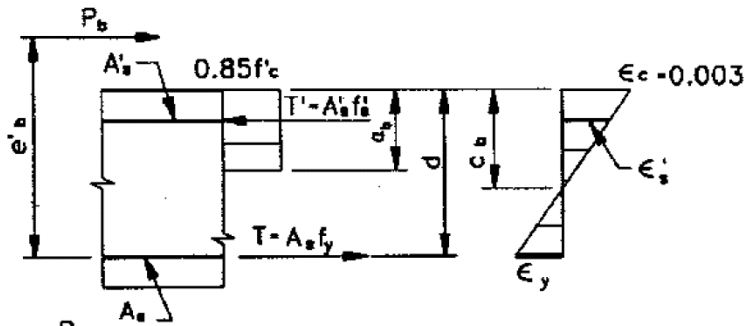

TENSION CONTROL

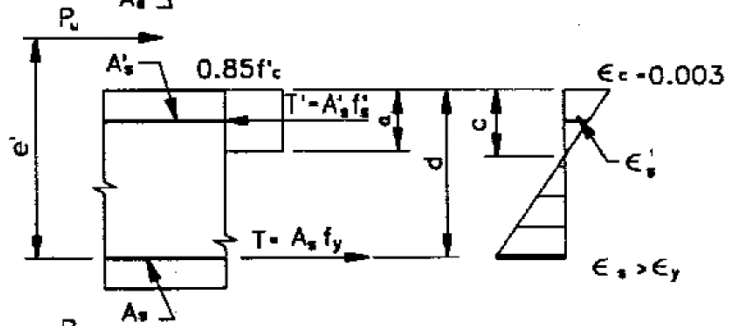

COMPRESSION CONTROL

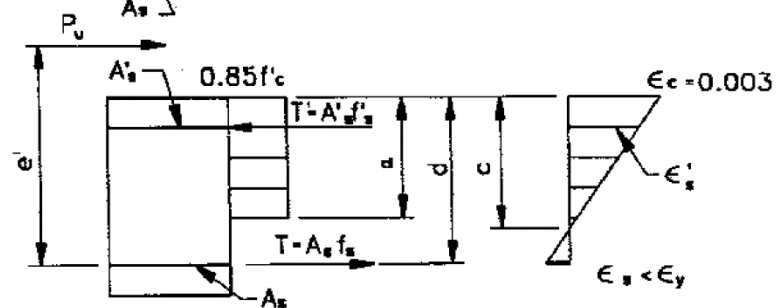

Figure B-2. Axial Compression and Flexure, Double Reinforcement.

B.3.4. Balanced Condition Equation B-28, which calculates the balanced eccentricity ratio of a member with flexural and compressive loadings and both tension and compression reinforcement, is derived as follows.

From equilibrium shown in Figure B-2:

$$\frac{P_u}{\phi} = 0.85 f'_c k_u b d + f'_s \rho' b d - f_s \rho b d \quad (\text{B-23})$$

In a manner similar to the derivation of Equation B-6, moment equilibrium results in:

$$\frac{P_u e'}{\phi} = 0.425 f'_c (2k_u - k_u^2) b d^2 + f'_s \rho' b d (d - d') \quad (\text{B-24})$$

As in Equation B-7:

$$k_b = \frac{\beta_1 E_s \epsilon_c}{E_s \epsilon_c + f_y} \quad (\text{B-25})$$

since

$$e'_b = \frac{P_b e'}{P_s} \quad (\text{B-26})$$

and using Equations B-23 and B-24:

$$e'_b = \frac{0.425 f'_c (2k_b - k_b^2) b d^2 + f'_s \rho' b d (d - d')}{0.85 f'_c k_b b d + f'_s \rho' b d - f_s \rho b d} \quad (\text{B-27})$$

which can be rewritten as:

$$e'_b = \frac{(2k_b - k_b^2) d + \frac{f'_s \rho'}{0.425 f'_c} (d - d')}{2k_b + \frac{f_s \rho'}{0.425 f'_c} - \frac{f_y \rho}{0.425 f'_c}}$$

or:



$$\frac{e'_b}{d} = \frac{2k_b - k_b^2 + \frac{f'_s \rho' \left(1 - \frac{d'}{d}\right)}{0.425 f'_c}}{2k_b - \frac{f_y \rho}{0.425 f'_c} + \frac{f'_s \rho'}{0.425 f'_c}} \quad (\text{B-28})$$

B.3.5. Sections Controlled by Tension. Members that have an eccentricity ratio higher than the balanced eccentricity ratio are controlled by their strength in tension and should be designed according to Equations B-29 and B-30. The derivation of the design equations and their relevant terms is shown below;  $\phi P_n$  is obtained as Equation B-23 with  $f_s = f_y$ :

$$\phi P_n = \phi \left( 0.85 f'_c k_u + \rho' f'_s - \rho f_y \right) b d \quad (\text{B-29})$$

Using Equations B-12 and B-29:

$$\phi M_n = \phi \left( 0.85 f'_c k_u + \rho' f'_s - \rho f_y \right) \left[ \frac{e'}{d} - \left( 1 - \frac{h}{2d} \right) \right] b d^2 \quad (\text{B-30})$$

From Figure B-2:

$$\frac{\varepsilon'_s}{c - d'} = \frac{\varepsilon_y}{d - c}; \quad f'_s = E_s \varepsilon'_s; \quad c = \frac{k_u d}{\beta_1}$$

Therefore:

$$\frac{f'_s}{E_s} = \left( \frac{k_u d}{\beta_1} - d' \right) \left( \frac{\varepsilon_y}{d - \frac{k_u d}{\beta_1}} \right)$$

or:

$$f'_s = \frac{\left( k_u - \beta_1 \frac{d'}{d} \right)}{\left( \beta_1 - k_u \right)} E_s \varepsilon_y \quad (\leq f_y) \quad (\text{B-31})$$

Substituting Equation B-23 with  $f_s = f_y$  into Equation B-24 gives:

$$\left( 0.85 f'_c k_u b d + f'_s \rho' b d - f_y \rho b d \right) e' = 0.425 f'_c \left( 2k_u - k_u^2 \right) b d^2 + f'_s \rho' b d \left( d - d' \right) \quad (\text{B-32})$$

Using Equation B-31, Equation B-32 can be written as:

$$\begin{aligned}
 & k_u^3 + \left[ 2 \left( \frac{e'}{d} - 1 \right) - \beta_1 \right] k_u^2 \\
 & - \left\{ \frac{f_y}{0.425 f'_c} \left[ \rho' \left( \frac{e'}{d} + \frac{d'}{d} - 1 \right) + \frac{\rho e'}{d} \right] + 2 \beta_1 \left( \frac{e'}{d} - 1 \right) \right\} k_u \\
 & + \frac{f_y \beta_1}{0.425 f'_c} \left[ \rho' \frac{d'}{d} \left( \frac{e'}{d} + \frac{d'}{d} - 1 \right) + \frac{\rho e'}{d} \right] = 0
 \end{aligned} \tag{B-33}$$

**B.3.6. Sections Controlled by Compression.** Members that have an eccentricity ratio less than or equal to the balanced eccentricity ratio are controlled by their strength in compression and should be designed according to Equations B-34 and B-35 below. The derivation of the design equations and their relevant terms is shown below.

$\phi P_n$  is obtained from equilibrium:

$$\phi P_n = \phi (0.85 f'_c k_u + \rho' f'_s - \rho f_s) b d \tag{B-34}$$

Using Equations B-12 and B-34,

$$\phi M_n = \phi (0.85 f'_c k_u + \rho' f'_s - \rho f_s) \left[ \frac{e'}{d} - \left( 1 - \frac{h}{2d} \right) \right] b d^2 \tag{B-35}$$

From Figure B-2:

$$\frac{\varepsilon_s}{d - c} = \frac{\varepsilon_c}{c}; \quad f_s = E_s \varepsilon_s; \quad c = \frac{k_u d}{\beta_1}$$

which can be written as:

$$f_s = \frac{E_s \varepsilon_c (\beta_1 - k_u)}{k_u} \tag{B-36}$$

Also,

$$\frac{\varepsilon'_s}{c - d'} = \frac{\varepsilon_c}{c}$$

which can be rewritten as:

$$f'_s = \frac{E_s \varepsilon_c \left[ k_u - \beta_1 \left( \frac{d'}{d} \right) \right]}{k_u} \quad (\geq -f_y) \quad (\text{B-37})$$

From Equations B-23 and B-24,

$$\begin{aligned} (0.85 f'_c k_u b d = f'_s \rho' b d - f_s \rho b d) e' \\ = 0.425 f'_c (2k_u - k_u^2) b d^2 + f'_s \rho' b d (d - d') \end{aligned} \quad (\text{B-38})$$

Substituting Equations B-36 and B-37 with  $k_b = k_u$  into Equation B-38 gives:

$$\begin{aligned} k_u^3 + 2 \left( \frac{e'}{d} - 1 \right) k_u^2 + \frac{E_s \varepsilon_c}{0.425 f'_c} \left[ (\rho + \rho') \left( \frac{e'}{d} \right) - \rho' \left( 1 - \frac{d'}{d} \right) \right] k_u \\ - \frac{\beta_1 E_s \varepsilon_c}{0.425 f'_c} \left[ \rho' \left( \frac{d'}{d} \right) \left( \frac{e'}{d} + \frac{d'}{d} - 1 \right) + \rho \left( \frac{e'}{d} \right) \right] = 0 \end{aligned} \quad (\text{B-39})$$

#### B.4. Flexural and Tensile Capacity – Refer to Figure B-3.

B.4.1. This section should be used to design sections subject to tension and uniaxial flexure, regardless of reinforcement pattern.

B.4.2. The design axial strength  $\phi P_n$  of members loaded in tension is limited by ACI 318 and should not be taken greater than allowed by:

$$\phi P_{n(\max)} = 0.8 \phi (\rho + \rho') f_y b d \quad (\text{B-40})$$

B.4.3. Tensile reinforcement should be provided in both faces of the member if the load has an eccentricity ratio  $e'/d$  in the following range:

$$\left( 1 - \frac{h}{2d} \right) \geq \frac{e'}{d} \geq 0 \quad (\text{B-41})$$

Sections with eccentricity ratios in this range will generally be loaded axially between the two layers of reinforcement and both layers of reinforcement will be in tension. A section under a tensile load with an eccentricity ratio higher than  $(1 - \frac{h}{2d})$  will place the assumed tensile reinforcement into compression. Therefore the extreme compressive fiber should be assumed to be at the opposite face of the section and the eccentricity ratio should be recalculated.

B.4.4. Members governed by this chapter should be designed according to the criteria listed below.

B.4.5. Sections that are purely in tension and subject to no flexural load should be designed in accordance with Section B.4.5.

B.4.6. Sections under tension and uniaxial flexure that have  $\frac{e'}{d} > 0$  should be designed in accordance with Section B.4.6.

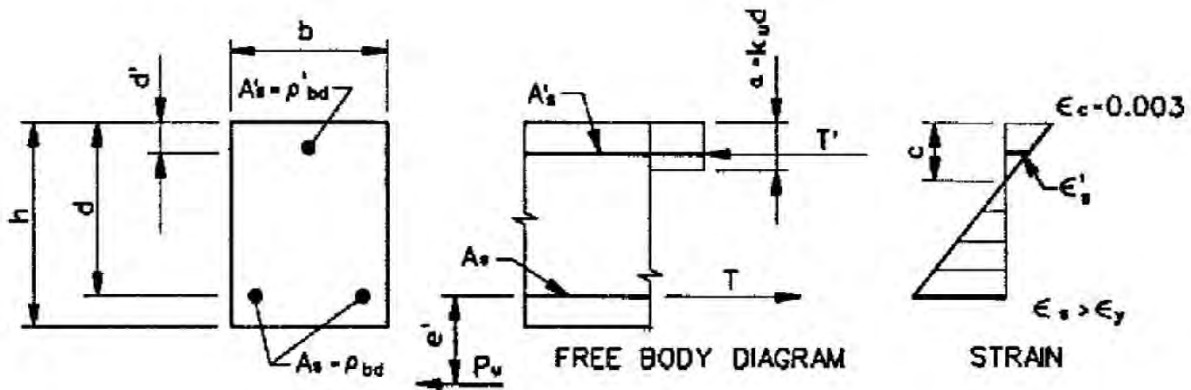

AXIAL TENSION, CONCRETE AT COMPRESSION FACE AT ULTIMATE STRAIN OF 0.003

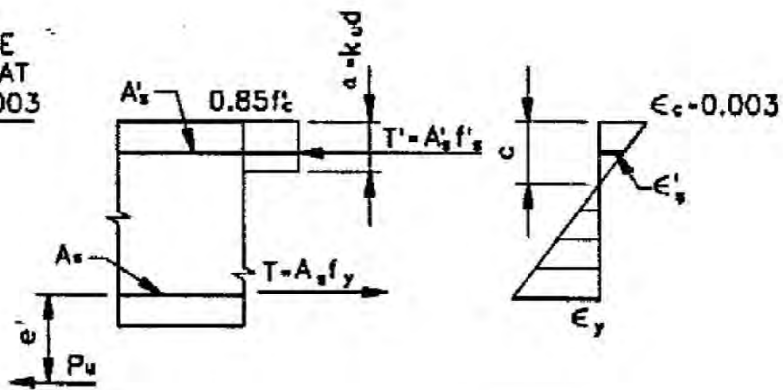

AXIAL TENSION, BOTH LAYERS OF STEEL IN TENSION

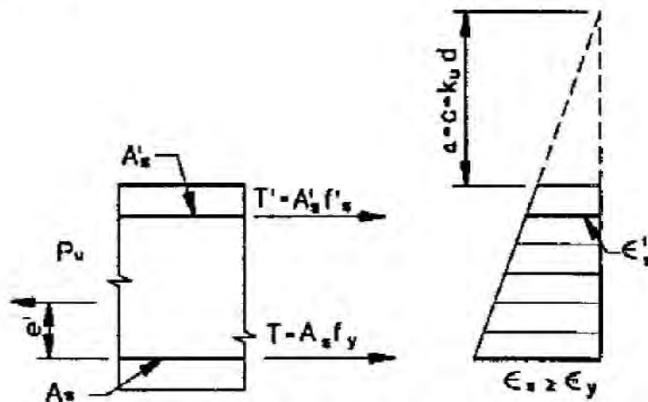

Figure B-3. Axial Tension and Flexure, Double Reinforcement.

B.4.7. Sections subjected to a tensile load with an eccentricity ratio  $\frac{e'}{d} < 0$  should be designed using Section B.2.5., when compressive reinforcement is not present ( $A'_s = 0$ ) or is not subject to a compressive load ( $c \leq d'$ ). This case is similar to the case where the member is subject to

compression and uniaxial flexure, where the member's strength is controlled by its tensile strength. However, the  $k_u$  is slightly different. The derivation of  $k_u$  for this case follows the derivation presented in Equation B-15, with the exception that the tensile load results in  $k_u$  having the value presented below in Equation B-42:

$$k_u = -\left(\frac{e'}{d} - 1\right) - \sqrt{\left(\frac{e'}{d} - 1\right)^2 + \left(\frac{\rho f_y}{0.425 f'_c}\right) \frac{e'}{d}} \quad (\text{B-42})$$

B.4.8. Sections subject to a tensile load with an eccentricity ratio  $\frac{e'}{d} < 0$  should be designed using Section B.3.5, when compressive reinforcement is present ( $A'_s > 0$ ) and subject to a compressive load ( $c > d'$ ). This case is similar to the case where the member is subject to compression and uniaxial flexure, and the member's strength is controlled by its tensile strength.

B.4.9. Pure Tension Case. Members that are purely in tension should be designed according to Equation B-40. The derivation of the design equation is shown below.

From equilibrium (double reinforcement):

$$\phi P_n = \phi (A_s + A'_s) f_y \quad (\text{B-43})$$

For design, the axial load strength of tension members is limited to 80% of the design axial load strength at zero eccentricity.

Therefore Equation B-43 can be simply converted to equal Equation B-40, restated as:

$$\phi P_{n(\max)} = 0.8\phi (\rho + \rho') f_y b d$$

B.4.10. For the case where  $1 - \frac{h}{2d} \geq \frac{e'}{d} \geq 0$ , the applied tensile resultant  $\frac{P_u}{\phi}$  lies between the two layers of steel. Members loaded in this manner should be designed according to Equations B-44 and B-45 below. The derivation of the design equations and their relevant terms is shown below:

from equilibrium:

$$\phi P_n = \phi (A_s f_y + A'_s f'_s)$$

or:

$$\phi P_n = \phi (\rho f_y + \rho' f'_s) b d \quad (\text{B-44})$$

and:

$$\phi M_n = \phi P_n \left[ \left( 1 - \frac{h}{2d} \right) - \frac{e'}{d} \right] d$$

or:

$$\phi M_n = \phi (\rho f_y + \rho' f'_s) \left[ \left( 1 - \frac{h}{2d} \right) - \frac{e'}{d} \right] b d^2 \quad (\text{B-45})$$

From Figure B-3:

$$\frac{\epsilon'_s}{a + d'} = \frac{\epsilon_y}{a + d}$$

which can be rewritten as:

$$f'_s = f_y \frac{\left( k_u + \frac{d'}{d} \right)}{(k_u + 1)} \quad (\text{B-46})$$

From Figure B-3, equilibrium requires:

$$A_s f_s e' = A'_s f'_s (d - d' - e') \quad (\text{B-47})$$

Substituting Equation B-46 and  $f_s = f_y$  into Equation B-47 results in:

$$k_u = \frac{\rho' \left( \frac{d'}{d} \right) \left( 1 - \frac{d'}{d} - \frac{e'}{d} \right) - \rho \left( \frac{e'}{d} \right)}{\rho \left( \frac{e'}{d} \right) - \rho' \left( 1 - \frac{d'}{d} - \frac{e'}{d} \right)} \quad (\text{B-48})$$

#### B.5. Flexural Capacity for Members with Tension Reinforcement Only – Refer to Figure B-1.

The design moment  $\phi M_n$  is expressed as:

$$\phi M_n = T \left( d - \frac{a}{2} \right) \quad (\text{B-49})$$

where:

$$a = \frac{A_s F_y}{0.85 f'_c b} \quad (\text{B-50})$$

#### B.6. Flexural Capacity for Members with Tension and Compression Reinforcement – Refer to Figure B-2.

The design moment  $\phi M_n$  is expressed as:

$$\phi M_n = C_c \left( d - \frac{a}{2} \right) + C_s (d - d') \quad (\text{B-51})$$

where:

$$C_c = 0.85 f'_c b a \quad (\text{B-52})$$

$$C_s = 0.85 (f'_s - 0.85 f'_c) A'_s \quad (\text{B-53})$$

APPENDIX C

Investigation Examples

C.1. General.

This appendix provides four investigative examples. The purpose of these examples is to illustrate the application of this Engineer Manual and ACI 318, to determine the flexural capacity of existing concrete sections of a single and reinforced beam (Section C.2) and of a beam with reinforcement on both faces (Section C.3); to create an interaction diagram using computer program CGSI (Section C.4); and to calculate the capacity of an existing concrete section with axial load and biaxial bending (Section C.5).

C.2. Example - Analysis of a Singly Reinforced Beam (Figure C-1).

Given:

$$\begin{aligned} \beta_1 &= 0.85 & f_c' &= 4 \text{ ksi} \\ E_s &= 29,000 \text{ ksi} & f_y &= 60 \text{ ksi} \\ & & A_s &= 1.58 \text{ in.}^2 \end{aligned}$$

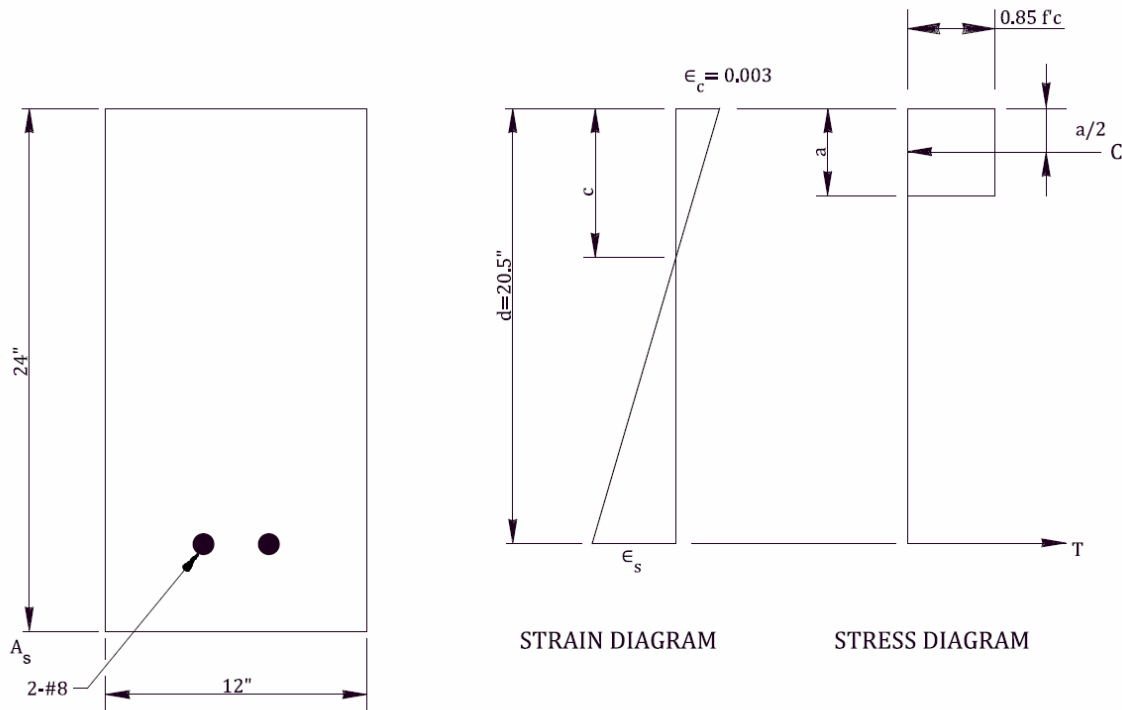

Figure C-1. Diagram of Singly Reinforced Beam Cross Section, Strain, and Stress.



Solution:

1. Check steel ratio.

$$\begin{aligned}\rho_{act} &= \frac{A_s}{bd} \\ &= \frac{1.58}{12(20.5)} \\ &= 0.006423\end{aligned}$$

$$\begin{aligned}\rho_b &= 0.85\beta_1 \frac{f'_c}{f_y} \left( \frac{87,000}{87,000 + f_y} \right) \\ &= 0.85(0.85) \left( \frac{4}{60} \right) \left( \frac{87,000}{87,000 + 60,000} \right) \\ &= 0.02851\end{aligned}$$

In accordance with Paragraph 3.5, Chapter 3:

$$0.25\rho_b = 0.00713$$

$$\rho_{act} = 0.00642$$

$$\rho_{act} < 0.25\rho_b$$

$P_{act}$  is less than the limit not requiring special study or investigation. Therefore, no special consideration for serviceability, constructability, and economy is required. This reinforced section is satisfactory.

1. Assume the steel yields and compute the internal forces.

$$T = A_s f_y = 1.58(60) = 94.8 \text{ kips}$$

$$C = 0.85 f'_c b a$$

$$C = 0.85(4)(12)a = 40.8a$$

2. From equilibrium set  $T = C$  and solve for  $a$ :

$$94.8 = 40.8a \rightarrow a = 2.324 \text{ in.}$$

$$\text{Then, } a = \beta_1 c \rightarrow c = \frac{2.324}{0.85} = 2.734 \text{ in.}$$

3. Check  $\epsilon_s$  to demonstrate steel yields prior to crushing of the concrete:

$$\frac{\epsilon_s}{20.5 - c} = \frac{0.003}{c}$$

$$\epsilon_s = (20.5 - 2.734) \left( \frac{0.003}{2.734} \right) = 0.01949$$

$$\epsilon_y = \frac{f_y}{E_s} = \frac{60}{29,000} = 0.00207$$

Given the results of this calculation, steel yields:

$$\epsilon_s > \epsilon_y$$

4. Compute the flexural capacity:

$$\begin{aligned} \phi M_n &= \phi (A_s f_y) (d - a/2) \\ &= 0.90 (1.58) (60) \left( 20.5 - \frac{2.324}{2} \right) \\ &= 1649.9 \text{ in.-k} \\ &= 137.5 \text{ ft-k} \end{aligned}$$

C.3. Example - Analysis of a Slab with Reinforcement in Both Faces (see Figure C-2).

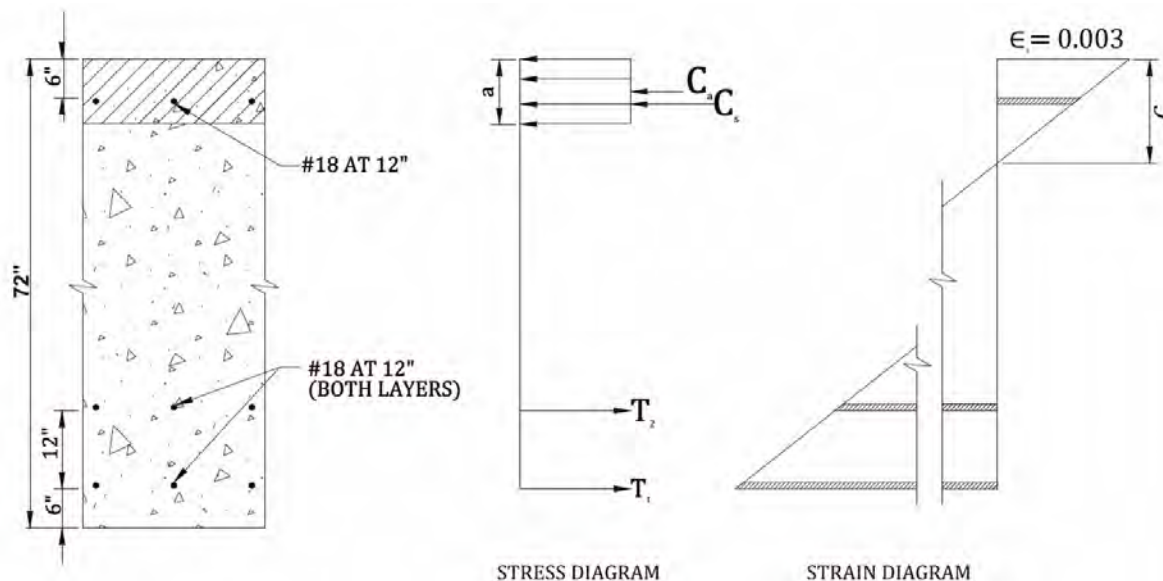

Figure C-2. Slab with Reinforcement on Both Faces with Diagram of Stress and Strain.

Given:

$$\begin{aligned} f'_c &= 4,000 \text{ psi} & \epsilon_c &= 0.003 \\ f_y &= 60,000 \text{ psi} & \beta_1 &= 0.85 \\ A_s &= 8.00 \text{ in.}^2 & E_s &= 29,000,000 \text{ psi} \\ A'_s &= 4.00 \text{ in.}^2 & \square \quad b &= 12 \text{ in.} \quad \square \end{aligned}$$

Solution:

1. First analyze considering steel in tension face only.

$$\begin{aligned} \rho &= \frac{A_s}{bd} = \frac{8}{(12)(60)} = 0.011 \\ \rho_{bal} &= 0.85 \frac{\beta_1 f'_c}{f_y} \left( \frac{87,000}{87,000 + f_y} \right) = 0.0285 \\ \rho &= \frac{0.011}{0.0285} \rho_{bal} = 0.39 \rho_b \end{aligned}$$

Note:  $\rho$  that exceeds maximum permitted upper limit not requiring special study or investigation equals  $0.25 \rho_b$ . See Chapter 3.

$$T = A_s f_y$$

$$T = 8(60) = 480 \text{ kips}$$

$$C_c = 0.85 f'_c b a = 40.8 a$$

Then:

$$T = C_c$$

$$\therefore a = 11.76 \text{ in. and } c = 13.84 \text{ in.}$$

By similar triangles, demonstrate that steel yields.

$$\frac{\epsilon_c}{13.84} = \frac{\epsilon_{s(2)}}{54 - 13.84} \Rightarrow \epsilon_{s(2)} = 0.00871 > \epsilon_y = 0.0021$$

Given the results of this calculation, both layers of steel yield.

$$\begin{aligned} \text{Moment capacity} &= 480 \text{ kips (d - a / 2)} \\ &= 480 \text{ kips (60 - 5.88)} \end{aligned}$$

$$M = 25,976.5 \text{ in.} - \text{k}$$

2. Next analyze the situation considering steel in compression face.

$$\rho' = \frac{A'_s}{bd} = \frac{4}{12(60)} = 0.0056$$

$$\rho - \rho' = 0.0054$$

$$= 0.85 \frac{\beta_1 f'_c}{f_y} \bullet \frac{d'}{d} \left( \frac{87,000}{87,000 - f_y} \right) = 0.01552$$

$$\rho - \rho' \leq 0.01552$$

∴ Compression steel does not yield, must do general analysis using  $\sigma : \epsilon$  compatibility.

Locate neutral axis:

$$T = 480 \text{ kips}$$

$$C_c = 0.85 f'_c b a = 40.8 a$$

$$C_s = A'_s (f'_s - 0.85 f'_c) = 4 (f'_s - 3.4)$$

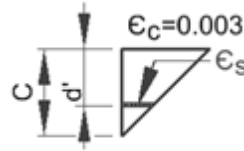

By similar triangles:  $\frac{\epsilon'_s}{c - 6} = \frac{0.003}{c}$

Substitute:  $c = \frac{a}{0.85} = 1.176a$

Then:  $\epsilon'_s = 0.003 - \frac{0.0153}{a}$

Since:  $f'_s = E \epsilon'_s \Rightarrow f'_s = \left( 87 - \frac{443.7}{a} \right) \text{ ksi}$

$$C_s = 4 \left( 87 - 3.4 - \frac{443.7}{a} \right) \text{ kips}$$

Then:  $T = C_c + C_s = 480 \text{ kips}$

Substitute for  $C_c$  and  $C_s$  and solve for  $a$ :

$$40.8a + 334.4 - \frac{1774.8}{a} = 480$$

$$a^2 - 3.57a - 43.5 = 0$$

Then  $a = 8.62$  in.

And  $c = 10.14$  in.

Check  $\epsilon'_s > \epsilon_y$

By similar triangles: 
$$\frac{0.003}{10.14} = \frac{\epsilon'_s}{d - 10.14}$$

$$\epsilon'_s = 0.0148 > 0.0021$$

$$C_c = 40.8a = 351.6 \text{ kips}$$

$$C_s = 4(32.11) = 128.4 \text{ kips}$$

$$C_c + C_s = 480 \text{ kips} = T$$

Resultant of  $C_c$  and  $C_s = \frac{351.6 \left( \frac{8.62}{2} \right) + (128.4)(6)}{480} = 4.76 \text{ in.}$

Internal Moment Arm =  $60 - 4.76 = 55.24$  in.

$$M = 480 (55.24) = 26,515.2 \text{ in. - k}$$

Table C-1 lists the  $a$ ,  $c$ , Arm, and  $M$  (moment capacity) for a beam with tension steel only and a beam with reinforcement on both faces.

Table C-1. Moment Capacity of a Beam with Tension Steel Only and of a Beam with the Addition of Compression Steel.

	Tension Steel Only	Compression Steel
a	11.76 in.	8.62 in.
c	13.84 in.	10.14 in.
Arm	54.11 in.	55.24 in.
M	25,976.5 in. - k	26,515.2 in. - k

A 2.1% increase in moment capacity is observed with steel reinforcement in the compression zone.

C.4. Example –Construction of Interaction Diagram (see Figure C-3).

A complete discussion on the construction of interaction diagrams is beyond the scope of this manual. However, to demonstrate how the equations presented in Chapter 4 are used to construct a diagram, a few basic points will be computed. Note that the effects of  $\phi$ , the strength reduction factor, have not been considered. Using the example cross section shown below, compute the points defined by 1, 2, 3 notations shown in Figure C-3.

Given:

$$f'_c = 4.0 \text{ ksi}$$

$$f_y = 60 \text{ ksi}$$

$$A_s = \rho b d = 2.0 \text{ sq. in.}$$

$$d = 22 \text{ in.}$$

$$h = 24 \text{ in.}$$

$$b = 12 \text{ in.}$$

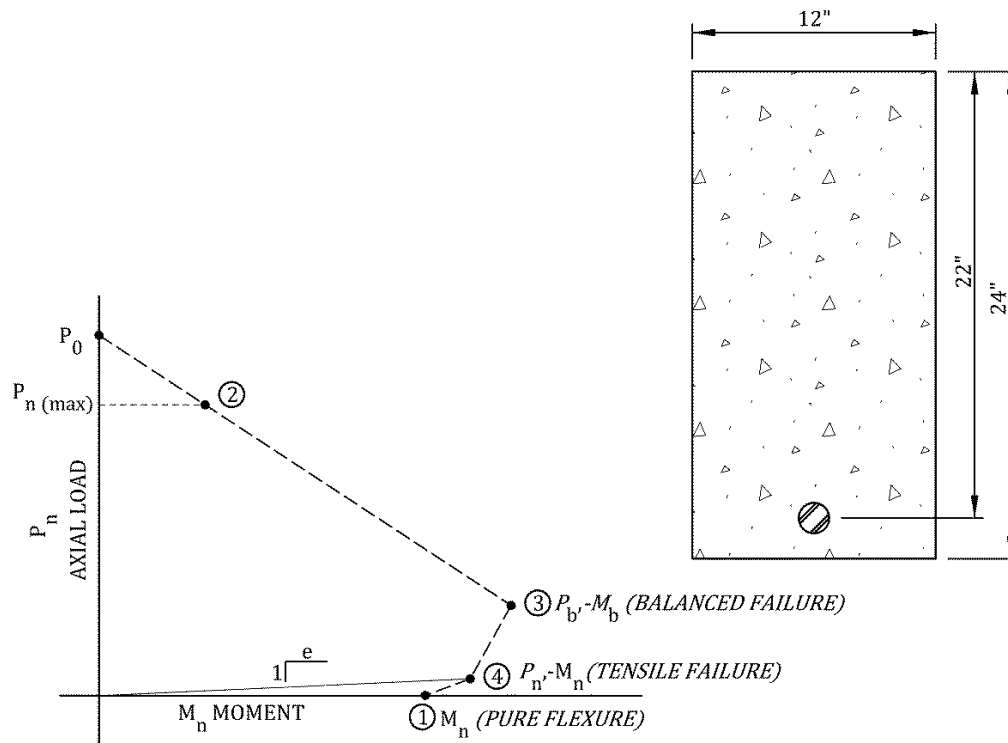

Figure C-3. General Interaction Diagram points and Given Cross Section.

C.4.1. Determination of Point 1, Pure Flexure (presented in Figure C-4).

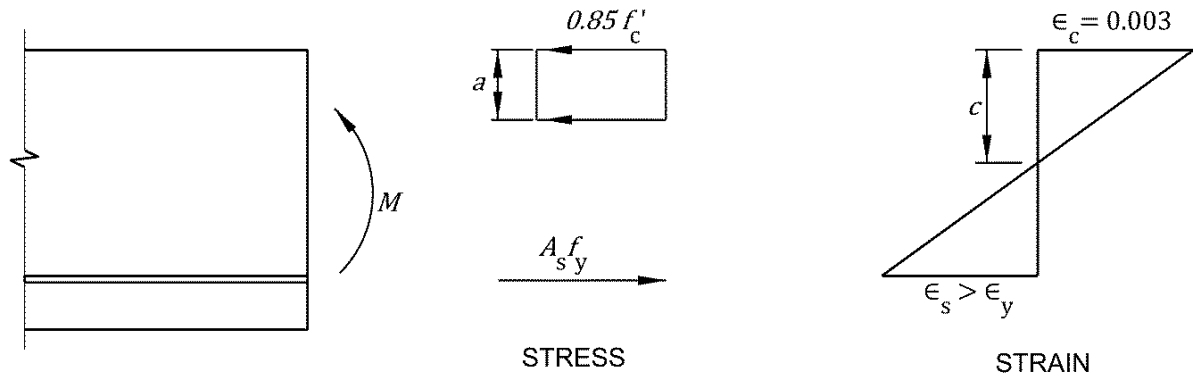

Figure C-4. Stress and Strain under Pure Flexure.

$$\phi M_n = \phi 0.85 f'_c ab \left( d - \frac{a}{2} \right)$$

$$a = \frac{A_s f_y}{0.85 f'_c b} = \frac{(2.0)(60.0)}{(0.85)(4.0)(12)} = 2.941 \text{ in.}$$

$$M_n = (0.85)(4.0)(2.941)(12) \left( 22 - \frac{2.941}{2} \right)$$

$$M_n = 2,463.5 \text{ k-in.}$$

$$M_n = 205.3 \text{ k-ft}$$

C.4.2. Determination of Point 2, Maximum Axial Capacity (presented in Figure C-5).

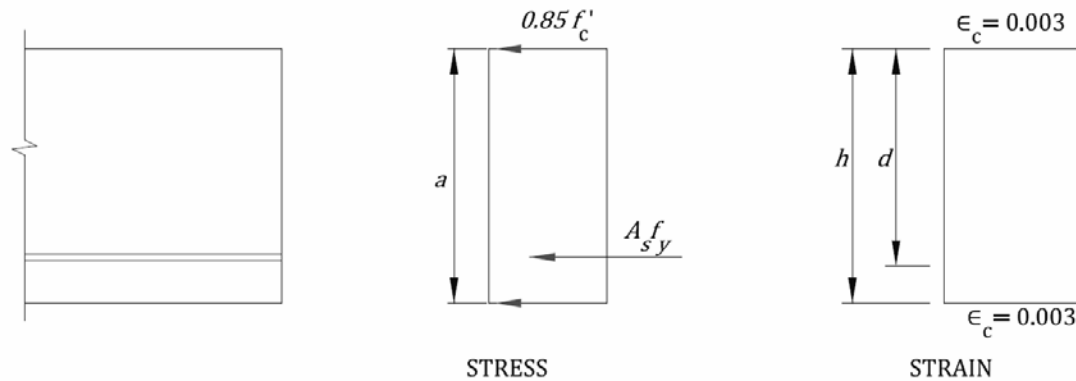

Figure C-5. Stress and Strain under Maximum Axial Load.

$$\phi P_{n(max)} = \phi 0.80 P_o$$

$$\phi P_{n(max)} = \phi 0.80 [0.85 f'_c (A_g - \rho b d) + f_y \rho b d]$$

$$P_{n(max)} = 0.80 [(0.85)(4.0)(288 - 2.0) + (60.0)(2.0)]$$

$$P_{n(max)} = 0.80(1092.4) = 873.9 \text{ kips}$$

C.4.3. Determination of Point 3, Balanced Point (presented in Figure C-6).

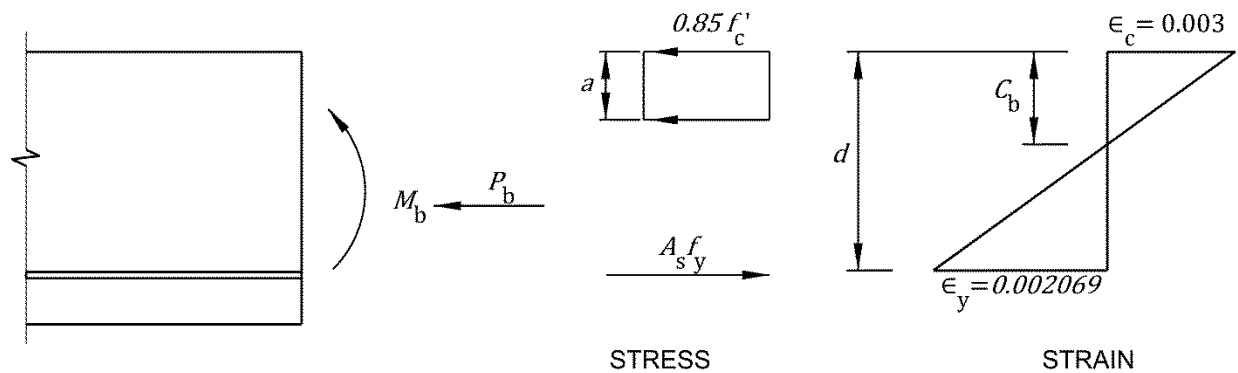

Figure C-6. Stress and Strain at Balanced Point.

1. Find  $k_b$ :

$$k_b = \frac{\beta_1 E_s \epsilon_c}{E_s \epsilon_c + f_y}$$

$$k_b = \frac{(0.85)(29,000)(0.003)}{(29,000)(0.003) + 60} = 0.5031$$



Then  $k_b$  is equal to  $k_u$  when balanced condition.

2. Find  $\frac{e'_b}{d}$ :

$$\frac{e'_b}{d} = \frac{2k_u - k_u^2}{2k_u - \frac{\rho f_y}{0.425 f'_c}}$$

$$\frac{e'_b}{d} = \frac{2(0.5031) - (0.5031)^2}{2(0.5031) - \frac{(0.00758)(60)}{(0.425)(4.0)}} = 1.01952$$

3. Find  $P_b$ :

$$\phi P_b = \phi [0.85 f'_c k_b - \rho f_y] b d$$

$$P_b = [(0.85)(4.0)(0.5031) - (0.00758)(60)](12)(22)$$

$$P_b = 331.52 \text{ kips}$$

4. Find  $M_b$ :

$$\phi M_b = \phi [0.85 f'_c k_b - \rho f_y] \left[ \frac{e'_b}{d} - \left( 1 - \frac{h}{2d} \right) \right] b d^2$$

$$\begin{aligned} M_b &= [(0.85)(4.0)(0.5031) - (0.00758)(60)] \\ &\cdot \left[ 1.01952 - \left( 1 - \frac{24.0}{2(22.0)} \right) \right] (12)(22.0)^2 \end{aligned}$$

$$M_b = 4120.55 \text{ k-in}$$

$$M_b = 343.38 \text{ k-ft}$$

The interaction diagram shown in Figure C-7 illustrates the results of the calculation.

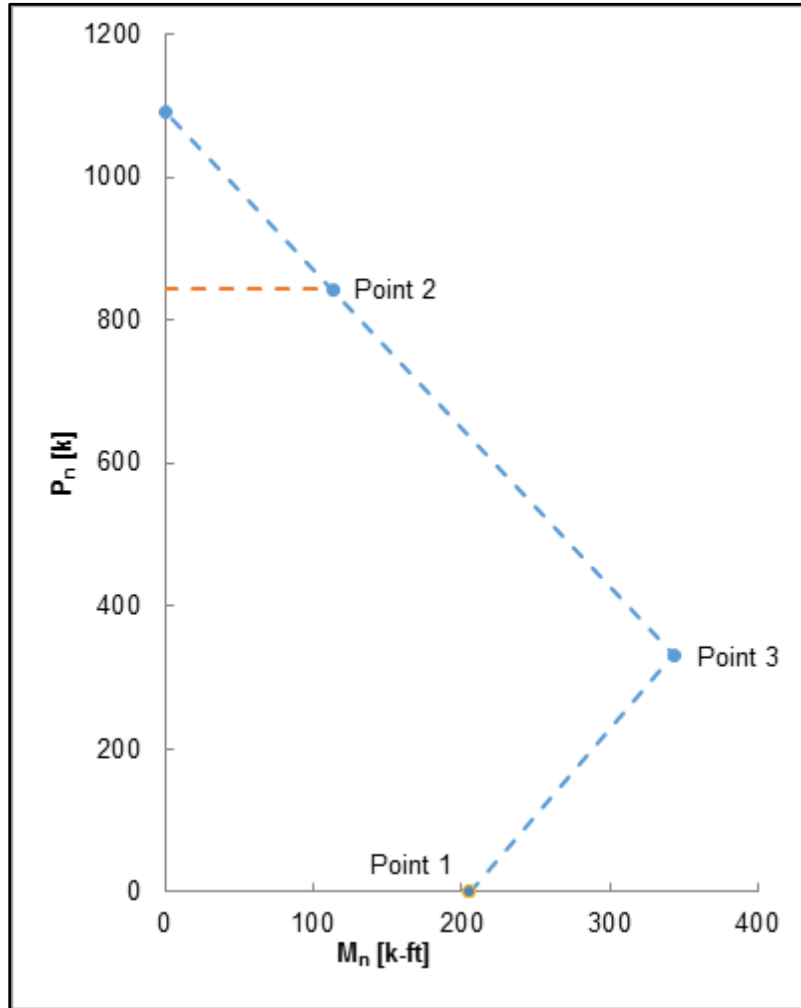

Figure C-7. Interaction Diagram for Combined Bending and Axial Forces.

The interaction diagram can also be formed using the program CGSI. An arbitrary load case of a moment of 100 k-ft was applied to generate the curve, but any load case can be used; the interaction diagram will remain the same. The nominal strength,  $M_n$  and  $P_n$ , interaction curve is the dashed line produced in CGSI. The interaction diagram developed using CGSI is presented in Figure C-8.

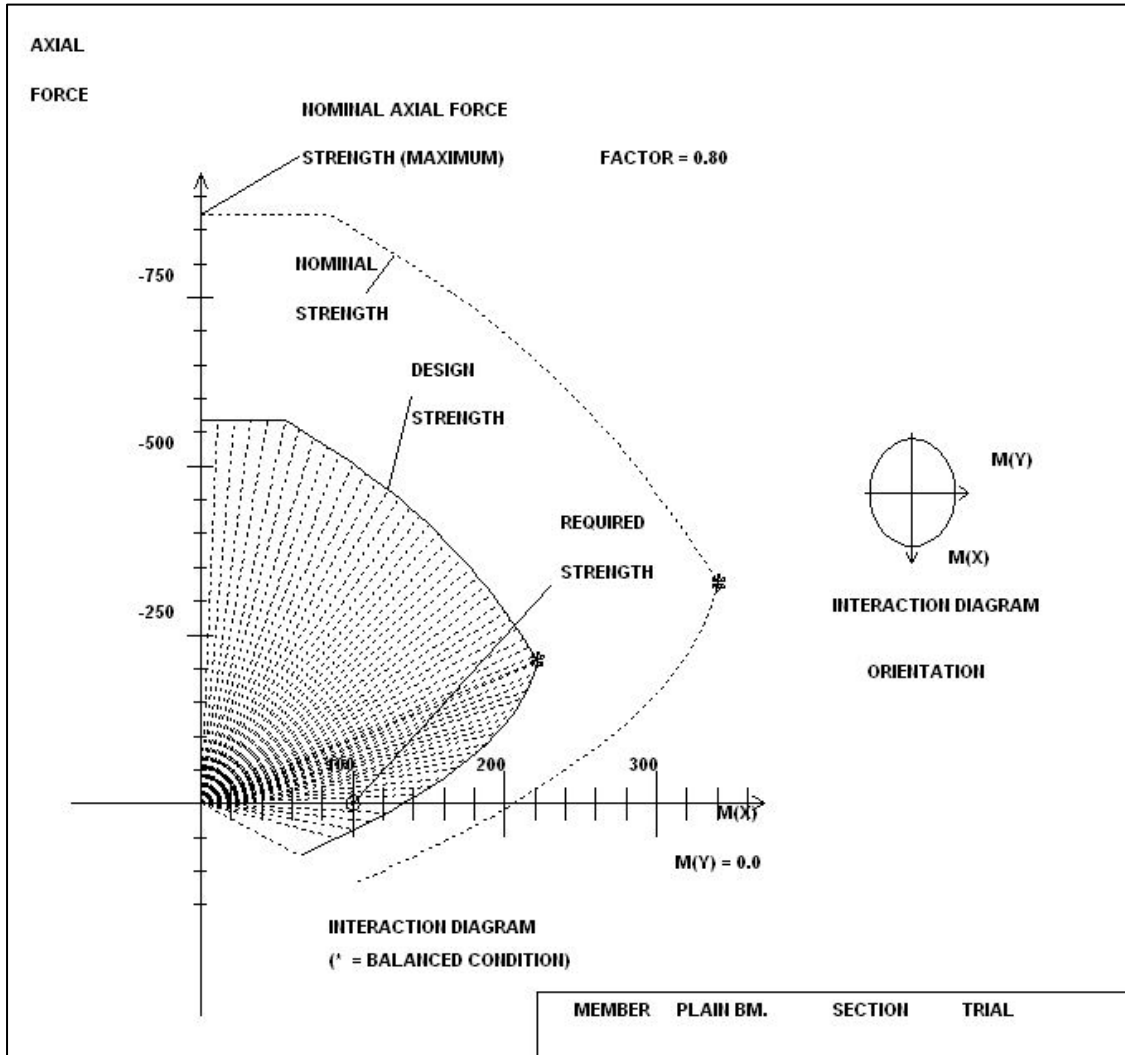

Figure C-8. Interaction Diagram produced in CGSI.

C.5. Example - Axial Load with Biaxial Bending (see Figure C-9).

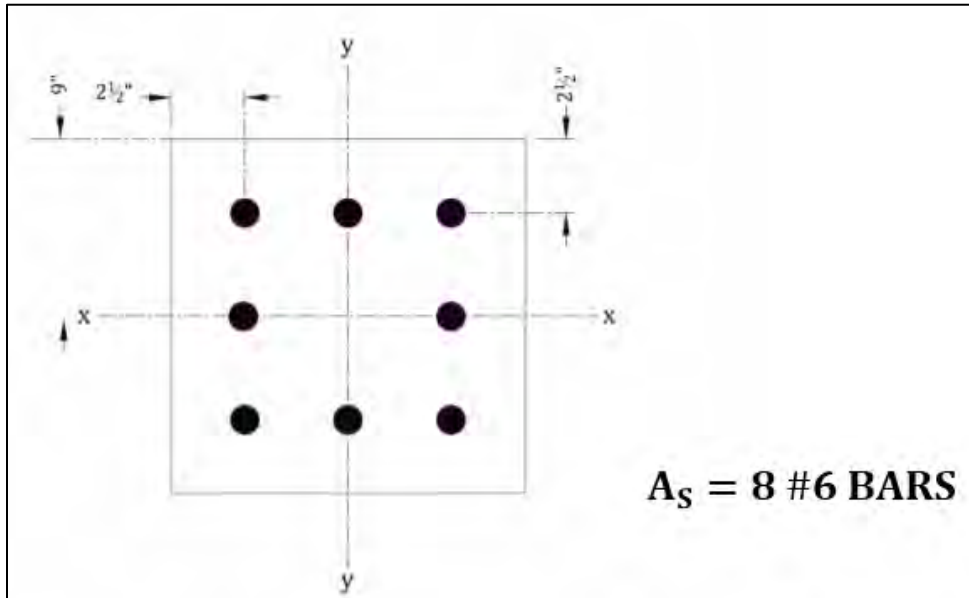

Figure C-9. Cross Section of Column with 8 #6 bars.

1. In accordance with Paragraph 4.3, design an 18 x 18-in. reinforced concrete column for the following conditions:

$$f'_c = 4,000 \text{ psi}$$

$$f_y = 60,000 \text{ psi}$$

$\phi = 0.65$  – for compression controlled regions

$$P_u = 300 \text{ kips}, \text{ Required } P_n = \frac{P_u}{0.65} = 462 \text{ kips}$$

$$M_{ux} = 94 \text{ ft} - \text{k}, \text{ Required } M_{rx} = \frac{M_{ux}}{0.65} = 145 \text{ ft} - \text{k}$$

$$M_{uy} = 30 \text{ ft} - \text{k}, \text{ Required } M_{ry} = \frac{M_{uy}}{0.65} = 46 \text{ ft} - \text{k}$$

Let concrete cover plus one-half a bar diameter equal 2.5 in.

2. Using uniaxial design procedures (Appendix B), select reinforcement for  $P_n$  and bending about the x-axis since  $M_{nx} > M_{ny}$ . The resulting cross section is given below.
3. Then use USACE Software CGSI to develop the interaction diagram. In Figures C-10 and C-11 show screenshots of the user inputs into the CGSI interface. The key changes to make are to select “User Input” under “solution type,” and then, in the bottom right-hand corner the user can input the current ACI code factors. The

Modulus of Elasticity of the concrete was found according to ACI 318. Material strength can also be adjusted. Also, the user needs to define the reinforcement locations and the load case data. In this example, the solution for both axes are found with a single load case, so both moments and axial load are input into one load case. With user input, a single strength reduction factor (PHI) is entered so the user needs to check that the value of PHI matches the required valued from ACI 318. The value of PHI depends on whether the member is loaded in the tension control region, compression control region, or in between (see Figure 4-1 for an illustration).

The screenshot shows the CGSI software interface with the following input data:

Name Descriptions	
User Name	EM2104 Example
Member Name	PLAIN BM.
Section Name	TRIAL

Material Strength	
Concrete Ultimate Strength (psi):	4000
Reinforcing Steel Yield Strength:	60000

Dimension Units	
<input checked="" type="radio"/> INCHES	
<input type="radio"/> FEET	

Solution Type	
<input type="radio"/> ACI 318 77 (A77)	
<input checked="" type="radio"/> USER INPUT (USER)	

Cross Section Geometry	
<input type="radio"/> DEFINED BY POINTS	
# Points	0
<input checked="" type="radio"/> RECTANGULAR DIMENSIONS	
Lower Left (Point 1)	Upper Right (Point 2)
X coord: 0	X coord: 18
Y coord: 0	Y coord: 18
<input type="radio"/> CIRCULAR DIMENSIONS	
Radius	Center
Outside: 0	X Coord: 0
Inside: 0	Y Coord: 0

View of Cross Section	
Replot	18.26 18.67

Reinforcement Data	
#Reinf. Sets	3

User Input Data (Solution Type)	
Strength Reduction Factor (PHI)	0.65
Maximum Concrete Strain (EMAX)	0.003
Modulus of Elasticity (EC)	3604997
Max. Conc. Stress/Ult. Strength (RK1)	0.85
Column Factor on Axial Strength (PMAXF)	0.8

Load Case Data	
# Loads Cases	2

Figure C-10. Inputs for CGSI.

User Input Data (Solution Type)		
Strength Reduction Factor	(PHI)	0.65
Maximum Concrete Strain	(EMAX)	0.003
Modulus of Elasticity	(EC)	3604997
Max. Conc. Stress/Ult. Strength	(RK1)	0.85
Column Factor on Axial Strength	(PMAXF)	0.8

Figure C-11. User Inputs for CGSI.

Once the user has inputted all of the data and load cases, then the analysis can be performed by selecting “Analyze” then “Go.” Then the interaction diagram is created as shown in Figure C-12. The point lies in the shaded region, so the capacity does exceed the demand. The value is in the compression controlled region above the balance point so PHI=0.65.

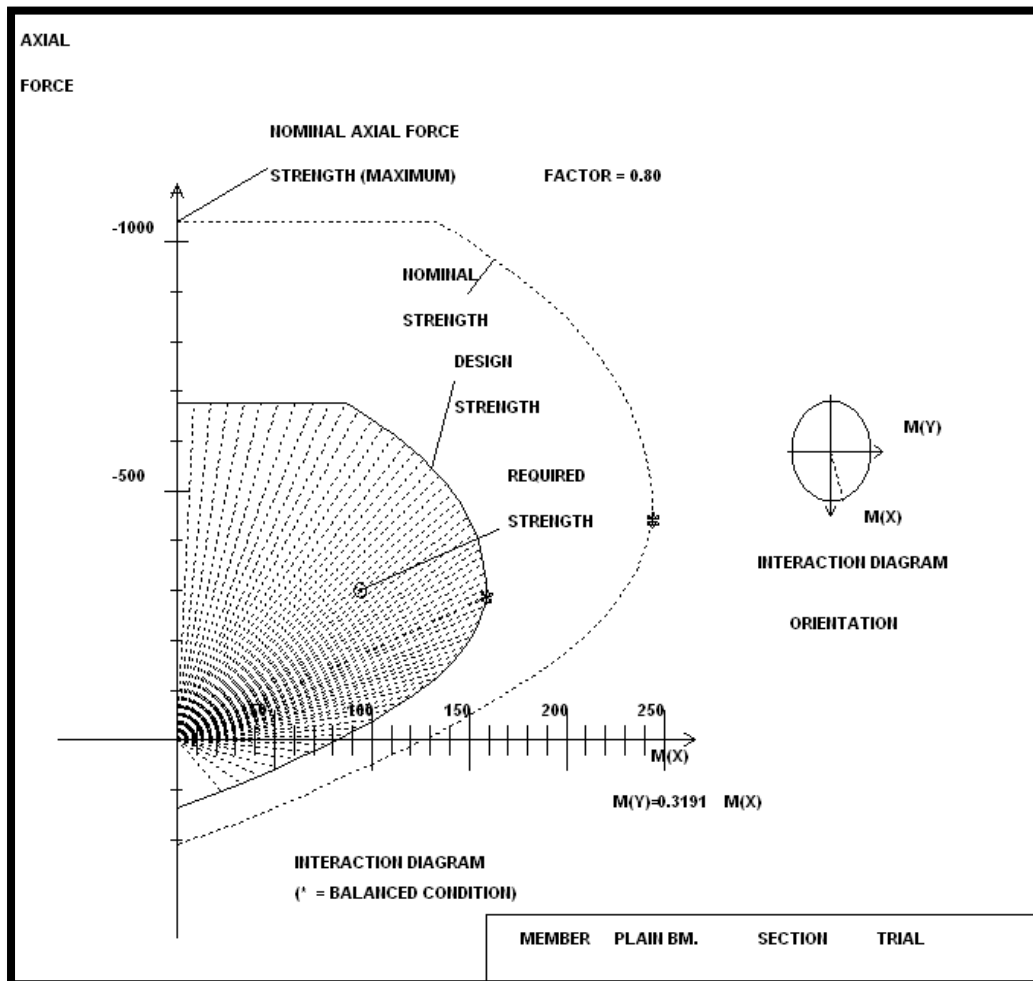

Figure C-12. Flexural Strength When Both Bending Moments are Acting Simultaneously.

The other method includes using the interaction equation, which is outlined below in combination with CGSI by applying  $M_{ny}$  and  $M_{nx}$  separately and generating two interaction diagrams, then by combining the results in the equation.

Figures C-13 and C-14, created in CGSI, present the nominal strength interaction diagrams about x and y axes. It is seen from Figure C-14 that the member is adequate for uniaxial bending about the y-axis with  $P_n = 462$  kips and  $M_{ny} = 46$  ft-kips. From Figures C-13 and C-14 at  $P_n = 462$  kips:

$$M_{nx} = 280 \text{ ft} - k$$

$$M_{ny} = 280 \text{ ft} - k$$

Which, for a square column, must satisfy:

$$\left(\frac{M_{rx}}{M_{nx}}\right)^{1.75} + \left(\frac{M_{ry}}{M_{ny}}\right)^{1.75} \leq 1.0$$

$$\left(\frac{145}{280}\right)^{1.75} + \left(\frac{46}{280}\right)^{1.75} = 0.36$$

If a value greater than 1.0 is obtained, increase reinforcement and/or increase member dimensions. This confirms the initial results from CGSI (Figure C-12).

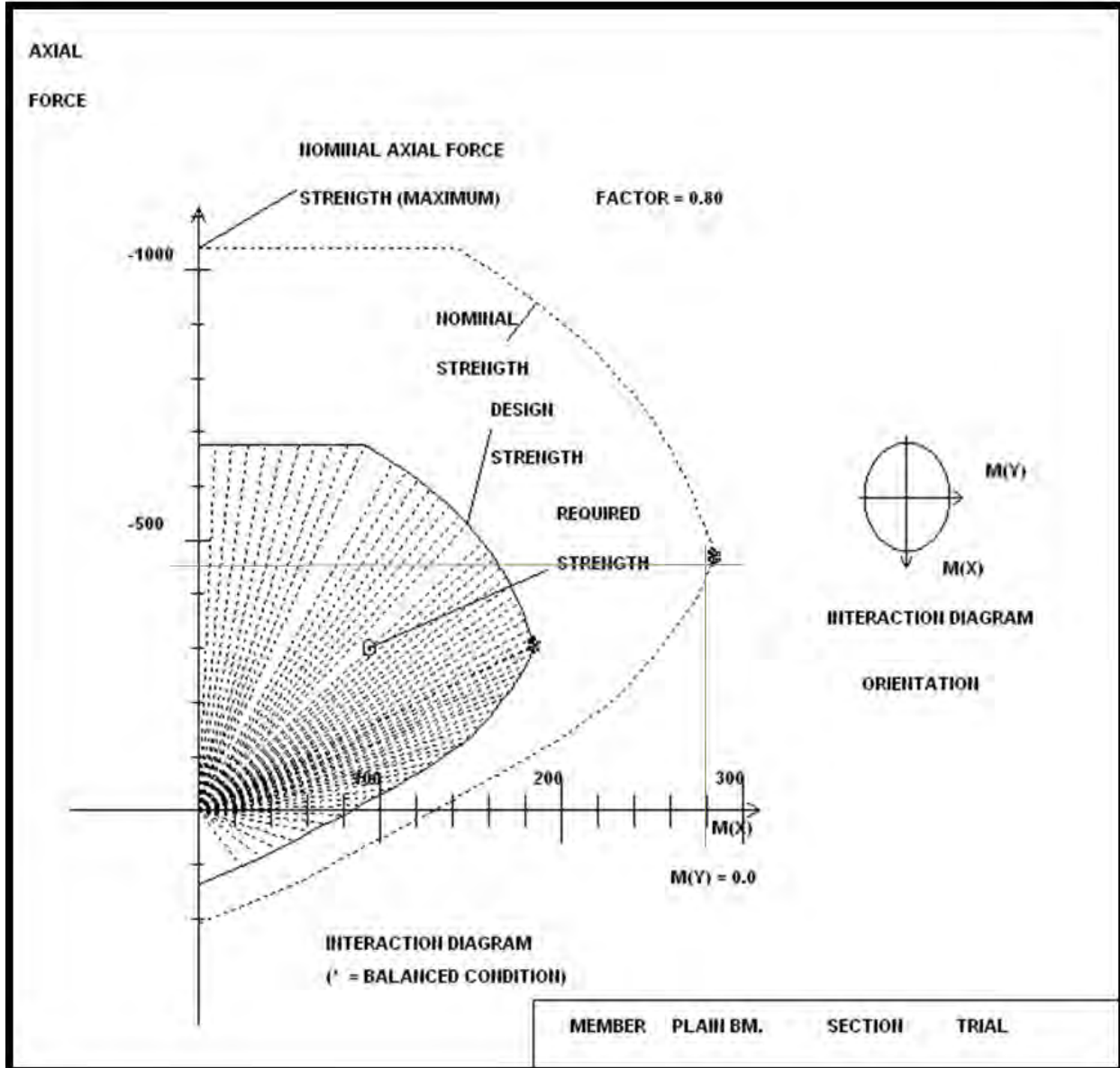

Figure C-13. Nominal Flexural Strength about the X-Axis.



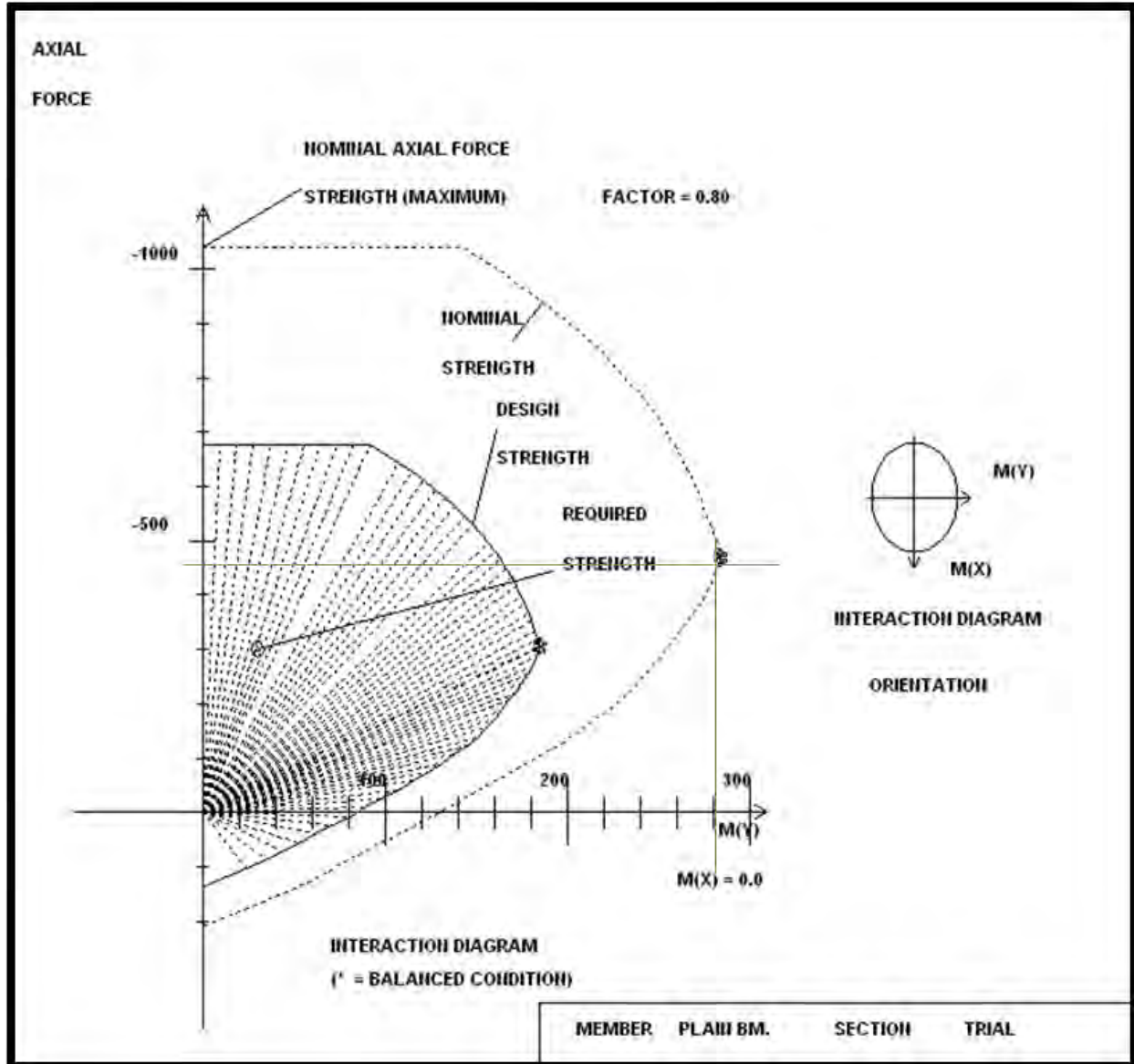

Figure C-14. Nominal Flexural Strength about the Y-Axis

APPENDIX D

Design Examples

D.1. General. This appendix provides derivation of design equations for singly and doubly reinforced members and design procedures (Section D.2); design examples of a singly reinforced retaining wall (Section D.3), a doubly reinforced retaining wall (Section D.4), and a combined flexure plus axially loaded retaining wall (Section D.5); a design example of a coastal floodwall (Section D.6); and a shear strength example for a special straight member (Section D.7) and for a curved member (Section D.8).

D.2. Design Equations and Procedures. The following paragraphs provide derivation of design equations for the singly reinforced and doubly reinforced members and design procedures.

1. Derivation of Design Equations for Singly Reinforced Members. Figure D-1 shows the conditions of stress on a singly reinforced member subjected to a moment  $M_n$  and load  $P_n$ . Equations for design may be developed by satisfying conditions of equilibrium on the section.

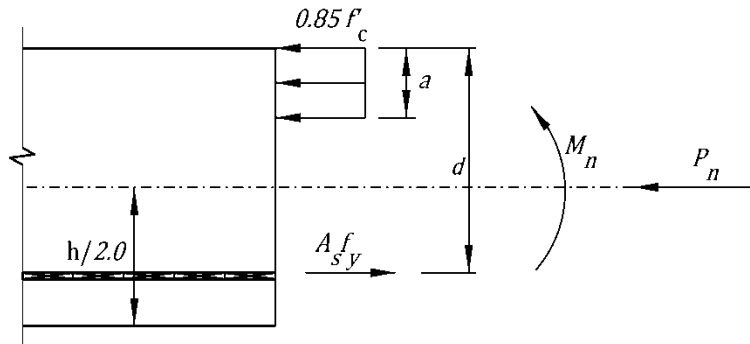

Figure D-1. Section of Stress for Singly Reinforced Member.

By requiring the  $\sum M$  about the tensile steel to equal zero:

$$M_n = 0.85f'_c ab \left( d - \frac{a}{2} \right) - P_n \left( d - \frac{h}{2} \right) \quad (D-1)$$

By requiring the  $\sum H$  to equal zero:

$$A_s f_y = 0.85f'_c ab - P_n \quad (D-2)$$

Expanding Equation D-1 yields:

$$M_n = 0.85f'_c abd - 0.425f'_c a^2 b - P_n \left( d - \frac{h}{2} \right)$$

Let  $a = K_u d$  then:

$$M_n = 0.85f'_c K_u b d^2 - 0.425f'_c K_u^2 d^2 b - P_n \left( d - \frac{h}{2} \right)$$

The above equation may be solved for  $K_u$  using the solution for a quadratic equation:

$$K_u = 1 - \sqrt{1 - \frac{M_n + P_n \left( d - \frac{h}{2} \right)}{0.425f'_c b d^2}}$$

Substituting  $K_{ud}$  for “ $a$ ” in Equation D-2 then yields:

$$A_s = \frac{0.85f'_c K_u b d - P_n}{f_y}$$

### D.2.1. Derivation of Design Equations for Doubly Reinforced Members.

Figure D-2 shows the conditions of stress and strain on a doubly reinforced member subjected to a moment  $M_n$  and load  $P_n$ . Equations for design are developed in a manner identical to that shown previously for singly reinforced beams.

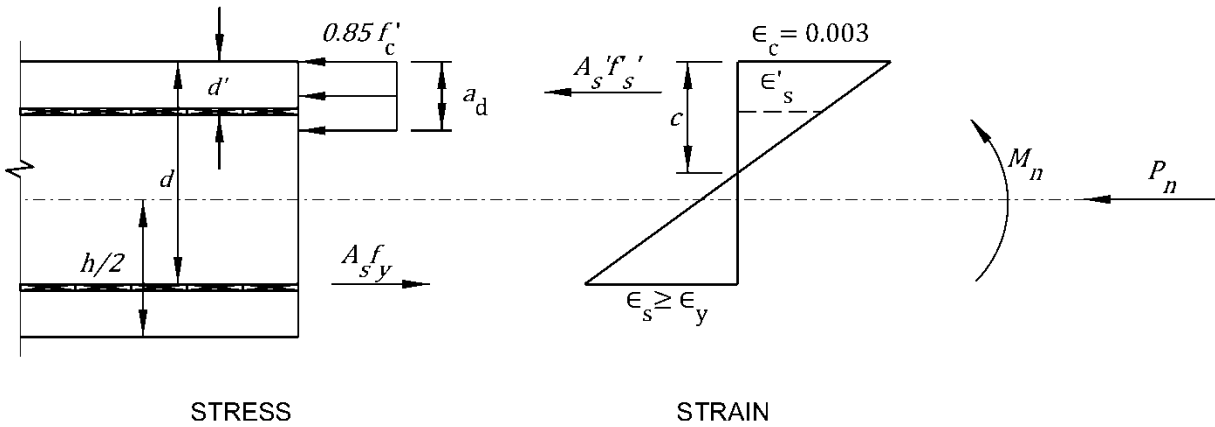

Figure D-2. Section of Stress and Strain for Doubly Reinforced Member.

By requiring the  $\sum H$  to equal zero yields:

$$A_s = \frac{0.85f'_c K_u b d - P_n + A'_s f'_s}{f_y} \quad (D-3)$$

By setting  $a_d = \beta_1 c$  and using the similar triangles from the strain diagram above,  $\epsilon'_s$  and  $f'_s$  may be found:

$$\epsilon'_s = \frac{\epsilon_y(c - d')}{d - c} = \frac{\epsilon_y \left( \frac{a_d}{\beta_1} - d' \right)}{d - \frac{a_d}{\beta_1}}$$

$$f'_s = \frac{(a_d - \beta_1 d') \epsilon_c E_s}{a_d}$$

An expression for the moment carried by the concrete ( $M_{DS}$ ) may be found by summing moments about the tensile steel of the concrete contribution.

$$M_{DS} = 0.85 f'_c a_d b \left( d - \frac{a_d}{2} \right) - \left( d - \frac{H}{2} \right) P_n$$

Finally, an expression for  $A'_s$  may be found by requiring the compression steel to carry any moment above that which the concrete can carry ( $M_n - M_{DS}$ ).

$$A'_s = \frac{M_n - M_{DS}}{f'_s (d - d')} \tag{D-4}$$

D.2.2. Derivation of the Expression  $d_d$ . The term  $d_d$  is the minimum effective depth a member may have and meet the limiting requirements on steel ratio. The expression for  $d_d$  is found by substituting  $a_d = k_d d_d$  in the equation shown above for  $M_{DS}$  and solving the resulting quadratic expression for  $d_d$ .

$$d_d = \sqrt{\frac{M_n}{0.85 f'_c k_d b \left( 1 - \frac{k_d}{2} \right)}} \tag{D-5}$$

### D.2.3. Design Procedure.

For convenience, a summary of the steps used in the design examples in this appendix is provided below. This procedure may be used to design flexural members subjected to pure flexure or flexure combined with axial load. The axial load may be tension or compression.

Step 1. Compute the required nominal strength,  $M_n$  and  $P_n$ , where  $M_u$  and  $P_u$  are determined in accordance with Paragraph 4.1:

$$M_n = \frac{M_u}{\phi}$$

$$P_n = \frac{P_u}{\phi}$$

Note: Step 2 below provides a convenient and quick check to ensure that members are sized properly to meet steel ratio limits. The expressions in Step 2a are adequate for flexure and small

axial load. For members with significant axial loads, the somewhat more lengthy procedures of Step 2b should be used.

Step 2a. Compute  $d_d$  from Table D-1. If  $d \geq d_d$  the member is of adequate depth to meet steel ratio requirements and  $A_s$  is determined using Step 3.

Step 2b. When significant axial load is present, the expressions for  $d_d$  become cumbersome and it becomes easier to check the member size by determining  $M_{DS}$ .  $M_{DS}$  is the maximum bending moment a member may carry and remain within the specified steel ratio limits.

$$M_{DS} = 0.85f'_c a_d b \left( d - \frac{a_d}{2} \right) - \left( d - \frac{h}{2} \right) P_n \quad (D-6)$$

where:

$$a_d = k_d d \quad (D-7)$$

and  $K_d$  is found from Table D-1.

Step 3. Singly Reinforced; when  $d \geq d_d$  (or  $M_n \leq M_{DS}$ ), the following equations are used to compute  $A_s$ :

$$K_u = 1 - \sqrt{1 - \frac{M_n + P_n \left( d - \frac{h}{2} \right)}{0.425f'_c b d^2}} \quad (D-8)$$

$$A_s = \frac{0.85f'_c K_u b d - P_n}{f_y} \quad (D-9)$$

Table D-1. Minimum Effective Depth.

$f'_c$ (psi)	$f_y$ (psi)	$\frac{\rho^*}{\rho_b}$	$K_d$	$d_d$ (in.)
3,000	60,000	0.25	0.125765	$\sqrt{\frac{3.3274M_n^{**}}{b}}$
4,000	60,000	0.25	0.125765	$\sqrt{\frac{2.4956M_n^{**}}{b}}$
5,000	60,000	0.25	0.118367	$\sqrt{\frac{2.1129M_n^{**}}{b}}$
* See Section 3.5, "Maximum Tension Reinforcement."				
** $M_n$ units are inch-kips.				

where:

$$K_d = \frac{\left(\frac{\rho}{\rho_b}\right) \beta_1 \epsilon_c}{\epsilon_c + \frac{f_y}{E_s}}$$

$$d_d = \sqrt{\frac{M_n}{0.85 f'_c k_d b \left(1 - \frac{k_d}{2}\right)}}$$

D.3. Singly Reinforced Example.

Figure D-3 shows a singly reinforced retaining wall demonstrating the use of the design procedure outlined in Paragraph D.2 for a Singly Reinforced Beam with the recommended steel ratio of  $0.25 \rho_b$ . The required area of steel is computed to carry the moment at the base of a retaining wall stem.

Given:  $M = 5$  k-ft (unfactored moment)

$f'_c = 4.0$  ksi

$f_y = 60$  ksi

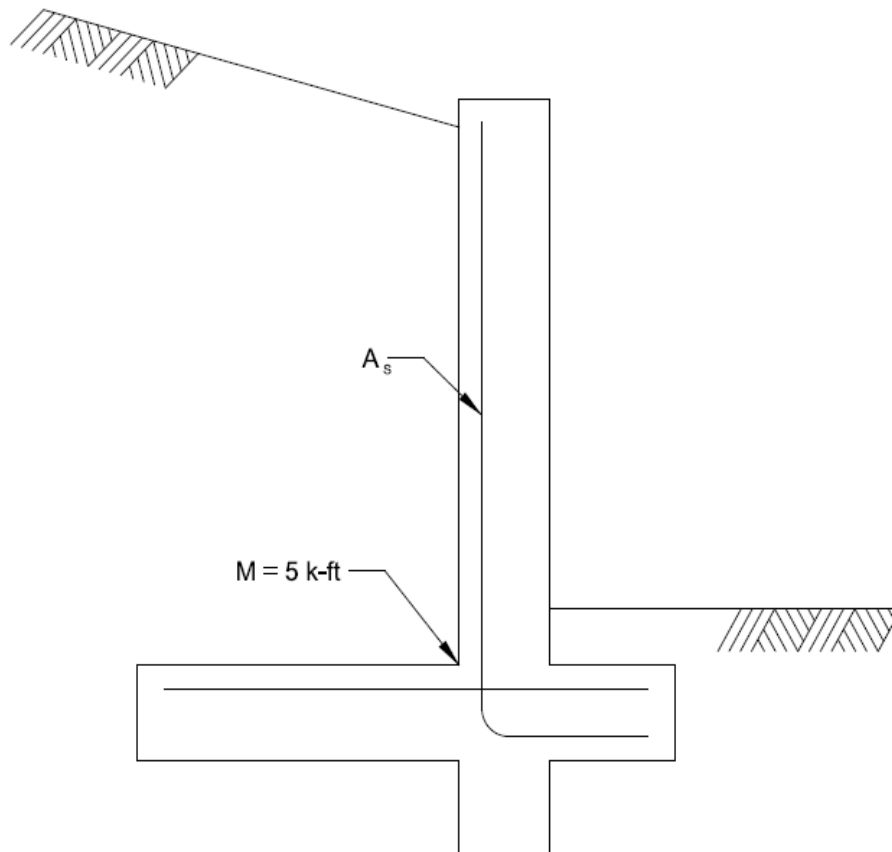

Figure D-3. Retaining Wall with Moment at the Base of Stem.

Step 1. Compute ultimate and nominal moments.

$$M_u = 2.2(Lp + Lt + Ld) = 2.2M$$

$$M_u = (2.2)(5) = 11 \text{ k-ft}$$

$$M_n = \frac{M_u}{\phi} = \frac{11(12)}{0.9} = 147 \text{ k-in.}$$

Step 2. Determine depth to reinforcement, d.

From Table D-1:

$$d_d = \sqrt{\frac{2.4956M_n}{b}} = \sqrt{\frac{2.4956(12.22)(12)}{12}} = 5.53 \text{ in.}$$

Use d = 6 in. so that d > d<sub>d</sub>

Step 3. Calculate K<sub>u</sub> and A<sub>s</sub> from Equations D-8 and D-9:

$$K_u = 1 - \sqrt{1 - \frac{M_n + P_n \left(d - \frac{h}{2}\right)}{0.425f'_c b d^2}} = 1 - \sqrt{1 - \frac{(12.22)(12)}{(0.425)(4.0)(12)(6)^2}} = 0.105$$

$$A_s = \frac{0.85f'_c K_u b d}{f_y} = \frac{(0.85)(4.0)(0.105)(12)(6)}{60} = 0.43 \text{ sq. in.}$$

Use No. 6 bars @ 12-in. c.c. spacing, A<sub>s</sub> = 0.44 sq. in.

Step 4. Check Reinforcement Ratio:

$$\begin{aligned} 0.25\rho_b &= 0.25 \left( 0.85\beta_1 \frac{f'_c}{f_y} \left( \frac{87000}{87000 + 60000} \right) \right) \\ &= 0.25(0.85)(0.85) \frac{4}{60} (0.5918) = 0.0071 \end{aligned}$$

$$\rho = \frac{A_s}{bd} = \frac{0.44}{12(6)} = 0.0061$$

$$\rho < 0.25\rho_b, \text{ therefore OK}$$

Determine Wall Thickness, h:

$$h = d + \frac{d_b}{2} + \text{cover} = 6 + \frac{0.75}{2} + 2 = 8.375 \text{ in}$$

Use  $h = 9$  in.

At this point, you can go through and re-compute the design capacities based on these final determinations, then proceed forward with the remaining checks (i.e., shear).

D.4. Doubly Reinforced Example.

Figure D-4, demonstrates the use of the design procedure outlined in Paragraphs C.3 and D.2 for a Doubly Reinforced Wall Section. Due to site constraints, you are restricted to a wall width of 18 in. Compute the required area of tensile and compression reinforcement necessary to carry the moment at the base of a retaining wall stem.

Given:  $M = 67.5$  k-ft (unfactored moment)

$$f'_c = 4.0 \text{ ksi}$$

$$f_y = 60 \text{ ksi}$$

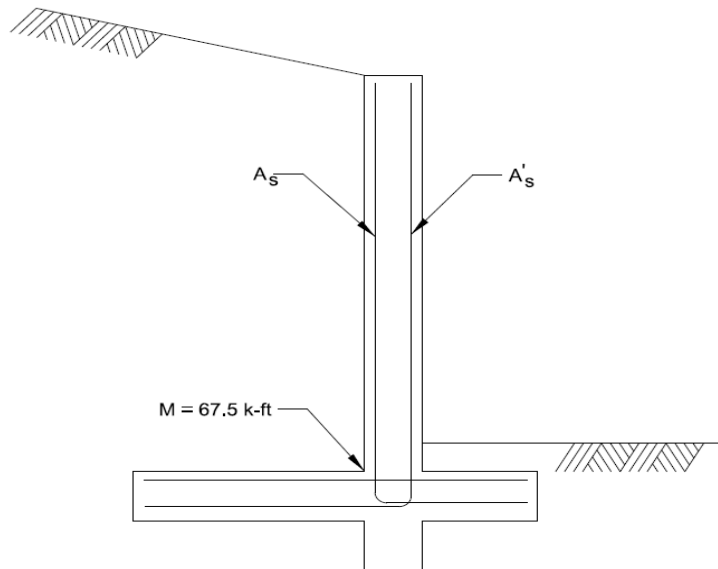

Figure D-4. Retaining Wall with Moment at the Base of Stem Doubly Reinforced.

Step 1. Determine ultimate and nominal moment.

$$M_u = 2.2(Lp + Lt + Ld) = 2.2M$$

$$M_{-u} = (2.2)(67.5) = 148.5 \text{ k - ft}$$

$$M_n = \frac{M_u}{\phi} = \frac{148.5(12)}{0.9} = 1980 \text{ k - in.}$$

Step 2. Determine depth to reinforcement. Assume maximum bar size equal to No. 11 bars.

$$d = 18 - 0.5d_b - \text{cover} = 18 - 0.5(1.41) - 3 = 14.295 \text{ in.}$$



$$d' = 0.5d_b + \text{cover} = 0.5(1.41) + 3 = 3.705 \text{ in.}$$

Step 3. Determine tension steel assuming singly reinforced. This step determines the max steel ratio the section can handle while maintaining  $0.25\rho_b$ .

$$A_{s1} = 0.25\rho_b bd = 0.25(0.0285)(12)(14.295) = 1.222 \text{ sq. in.}$$

$$T_s = C_c$$

$$A_{s1}f_y = 0.85f'_c\beta_1cb$$

$$1.222(60) = 0.85(4)(0.85)(12)c$$

$$c = 2.114 \text{ in.}$$

$$M_{n1} = A_{s1}f_y \left( d - \frac{\beta_1c}{2} \right) = 1.222(60) \left( 14.295 - \frac{0.85(2.114)}{2} \right) = 982.2 \text{ k-in.}$$

Step 4. Determine additional tension and compression steel. This step determines the additional steel required to handle the flexural strength demand while maintaining  $0.25\rho_b$ .

$$M_{n2} = M_n - M_{n1} = 1980 - 982.2 = 997.8 \text{ k-in.}$$

Assume compression steel yields:

$$M_{n2} = A'_s f_y (d - d') = A'_s (60)(14.295 - 3.705) = 635.4A'_s$$

$$A'_s = \frac{997.8}{635.4} = 1.570 \text{ sq. in.}$$

$$A_s = A_{s1} + A'_s = 1.222 + 1.570 = 2.792 \text{ sq. in.}$$

For tension reinforcement use No. 11 bars @ 6.5 in. c.c.,  $A_s = 2.88 \text{ sq. in.}$

For compression reinforcement use No. 11 bars @ 11 in. c.c.,  $A'_s = 1.70 \text{ sq. in.}$

Step 5. Check Assumptions.

Does compression steel yield:

$$\frac{A_s - A'_s}{bd} \geq 0.85\beta_1 \frac{f'_c}{f_y} \left( \frac{87000}{87000 - f_y} \right) \left( \frac{d'}{d} \right)$$

$$\frac{2.88 - 1.70}{12(14.295)} \geq 0.85(0.85) \left( \frac{4}{60} \right) \left( \frac{87000}{87000 - 60000} \right) \left( \frac{3.705}{14.295} \right)$$

$0.0069 < 0.0402$ , therefore compression steel does not yield

Step 6. Compute Nominal Moment Capacity. Since the compression steel does not yield, the capacity of the section is determined using the computed stress in the compression steel. It is assumed that the compression steel is properly tied.

$$C_s + C_c = T_s$$

$$C_s = A'_s f'_s = A'_s \epsilon'_s E_s = 1.70(29000) \left( 0.003 \frac{c - 3.705}{c} \right) = 147.9 - \frac{547.9}{c}$$

$$C_c = 0.85 f'_c \beta_1 c b = 0.85(4)(0.85)c(12) = 34.68c \text{ kips}$$

$$T_s = A_s f_y = 2.88(60) = 172.8 \text{ kips}$$

$$147.9 - \frac{547.9}{c} + 34.68c = 172.8$$

$$c^2 - 0.718c - 15.80 = 0$$

$$c = 4.38 \text{ in.}$$

Take moment about tension reinforcement to determine nominal moment capacity of the section:

$$\begin{aligned} M'_n &= C_c \left( d - \frac{\beta_1 c}{2} \right) + C_s (d - d') \\ &= 151.9 \left( 14.295 - \frac{0.85(4.38)}{2} \right) + 22.81(14.295 - 3.705) \end{aligned}$$

$$M'_n = 1888.6 + 241.6 = 2130 \text{ k-in.}$$

*Since  $M'_n > M_n$ , OK*

#### D.5. Combined Flexure Plus Axial Load Example.

Using the example shown in Figure D-5, it has been determined to site adapt the design to another location with the additional requirement to support an axial load of 25 kips/ft length, which includes self weight. Determine if the wall section, as is, can handle the additional axial load. If not, design the section necessary to handle the combined loading.

Given:  $M = 67.5$  k-ft (unfactored moment)

$P = 25$  kips (unfactored stem weight plus axial load)

$f'_c = 4.0$  ksi

$f_y = 60$  ksi

$A_s = 2.88$  sq. in.

$A'_s = 1.70$  sq. in.

$d = 14.295$  in.

$d' = 3.705$  in.

$e = 3.5$  in. (center of wall section to axial load).

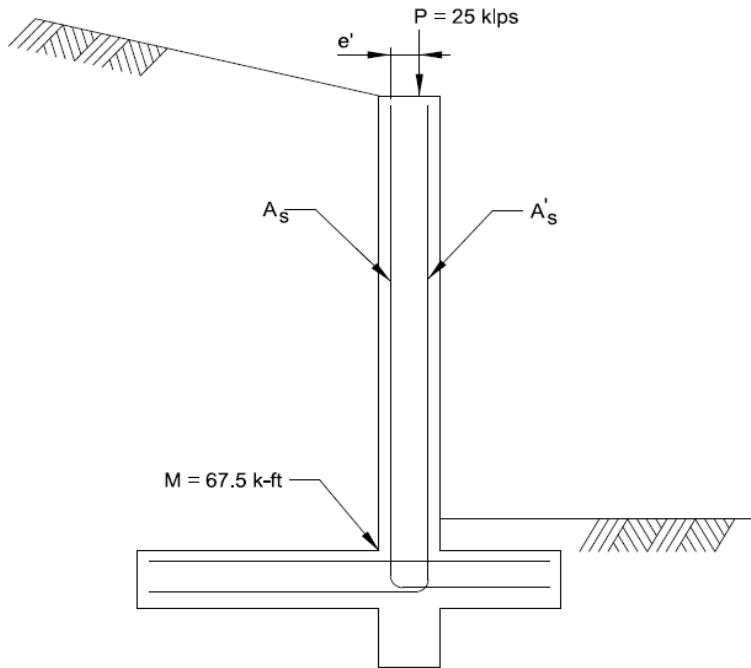

Figure D-5. Retaining Wall with Moment at the Base of Stem plus Axial Load.

Step 1. First compute the required strength,  $M_u, P_u$ :

$$M_u = 2.2(Lp + Lt + Ld) = 2.2M$$

$$M_u = (2.2)(67.5) = 148.5 \text{ k-ft}$$

$$P_u = 2.2(Lp + Lt + Ld) = 2.2P$$

$$P_u = 2.2(25) = 55 \text{ kips}$$

Because it is known that the section is tension controlled, for combined moment and axial force, it is possible to use  $\Phi = 0.9$ :

$$M_n = \frac{M_u}{\phi} = \frac{148.5(12)}{0.9} = 1980 \text{ k-in.}$$

$$P_n = \frac{P_u}{\phi} = \frac{55}{0.9} = 61 \text{ kips}$$

$$M_{n1} = M_n + P_n e = 1980 + 61(3.5) = 2194 \text{ k-in.}$$

Step 2. Determine balanced eccentricity ratio to determine if the section is controlled by strength in tension or strength in compression.

$$K_b = \frac{\beta_1 E_s \epsilon_c}{E_s \epsilon_c + f_y} = \frac{0.85(29000)(0.003)}{29000(0.003) + 60} = 0.503$$

$$e'_b = \frac{0.425f'_c(2K_b - K_b^2)bd^2 + f'_s \rho' bd(d-d')}{0.85f'_c K_b bd + f'_s \rho' bd - f_s \rho bd} = \frac{0.425(4)[2(0.503) - 0.503^2](12)(14.295)^2 + 13.41(0.0099)(12)(14.295)(14.295 - 3.705)}{0.85(4)(0.503)(12)(14.295) + (13.41)(0.0099)(12)(14.295) - 0.0168(12)(14.295)} = \frac{3139.0 + 241.2}{293.4 + 22.8 - 2.9} = 10.8$$

*Since  $e' > e'_b$ , section is controlled by strength in tension.*

Use equations in Section B.3.5.

Using Equation B-32 you get:

$$K_u^2 - 0.461K_u - 0.454 = 0$$

Solving the binomial equation, you get  $K_u = 0.943$

$$\begin{aligned} P_{n1} &= (0.85f'_c K_u + \rho' f'_s - \rho f_y)bd \\ &= [(0.85(4)(0.943) + 0.0099(13.41) - 0.0168(60)](12)(14.295) = (3.206 + 0.133 - 1.008)171.5 \\ &= 400 \text{ kips} \end{aligned}$$

*$P_{n1} > P_n$ , therefore OK.*

$$\begin{aligned} M_{n2} &= (0.85f'_c K_u + \rho' f'_s - \rho f_y) \left[ \frac{e'}{d} - \left(1 - \frac{h}{2d}\right) \right] bd^2 \\ &= [(0.85(4)(0.943) + 0.0099(13.41) - 0.0168(60)] \left[ \frac{11.0}{14.295} - \left(1 - \frac{18}{2(14.295)}\right) \right] (12)(14.295)^2 = (3.206 + 0.133 - 1.008)979 \\ &= 2282 \text{ k-in.} \end{aligned}$$

*$M_{n2} > M_{n1}$ , therefore OK.*

#### D.6. Design Example of Coastal Floodwall.

The following design example (see Table D-2 and Figure D-6) is intended to show the expanded use of the general guidance found in this EM.

Task: Design authorization has been approved for the design of a coastal floodwall in a navigational canal for a 100-yr storm event. Both 100- and 500-yr. storm event data have been provided. Based on geotechnical investigations, it was determined that the coastal floodwall is pile founded. The coastal floodwall will be reinforced concrete-founded on steel piles with a seepage cut-off wall. The pile foundation has been designed and the global pile reactions provided. Determine the wall stem and base slab thicknesses and reinforcement details.

Table D-2. Design Example of Coastal Floodwall.

Given Wall Geometrics					
Top of Wall:	16.0	ft.	*F.S. Base Width:	15.0	ft.
Top of Base:	-12.33	ft.	*P.S. Base Width:	10.0	ft.
Distance to Sheet Pile Cut-off from F.S. Toe:				11.5	ft.
* Base Slab Pile Cap widths and sheet pile cut-off location are based on pile foundation design not covered under this EM.					
Given Hydraulic Data					
100-yr SWL:	11.0	ft	500 yr. SWL:	14.8	ft
100-yr Wave Load:	5.32	k/ft	500 yr. Wave Load:	6.16	k/ft
100-yr Wave EL.:	-0.32	ft	500 yr. Wave EL.:	4.63	ft
Normal Water EL.:	1.0	ft	P.S. Low Water EL.:	-1.9	ft
Given Geotechnical Data					
F.S. Soil EL.:	-10.0	ft.	$K_o$ :	0.524	
P.S. Soil EL.:	-10.0	ft	$\gamma_s$ :	0.115	ksf
Other Given Data					
Debris Impact:	0.5	k/ft	Construction Surcharge:	0.20	ksf
Aberrant Barge Impact:	400	kips	$f'c$ :	4	ksi

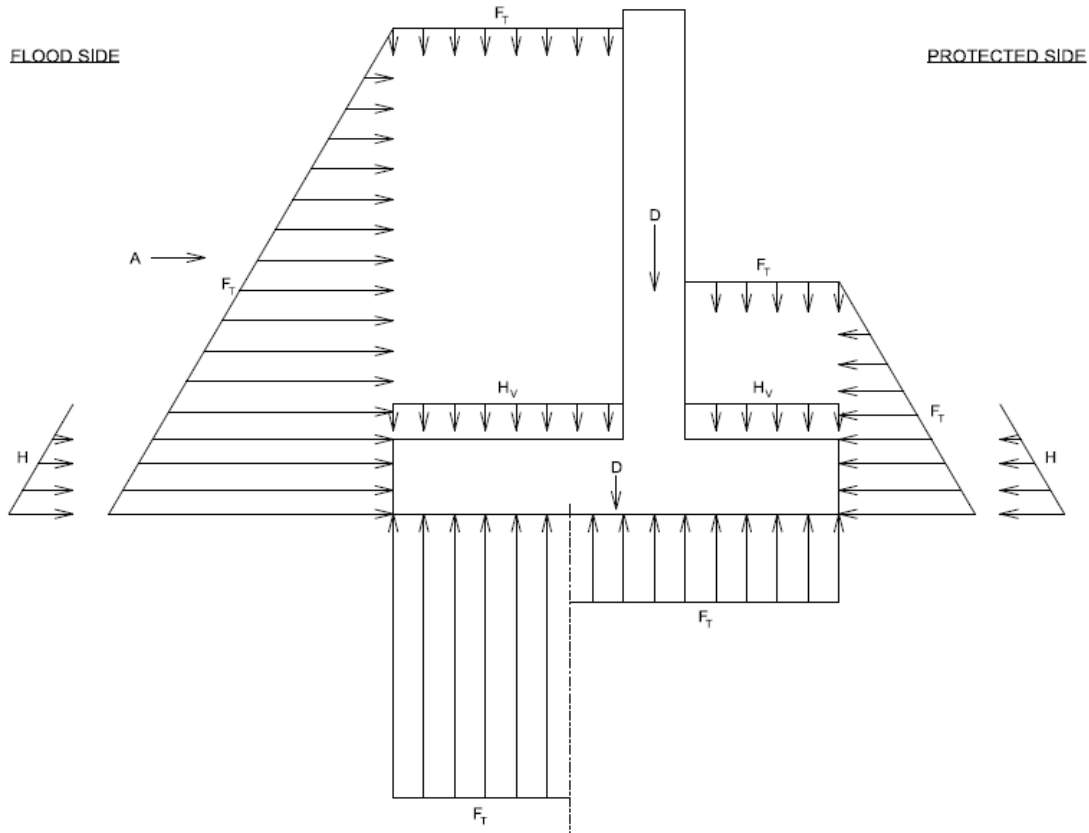

Figure D-6. Coastal Floodwall with Load Case C1B.1 Loads.

Step 1. Determine loads and load combinations in accordance with Section E.4.

Table D-3. Loads and Load Combinations in Accordance with Section E.4.

Load Case	Load Description	Category	No.	Factored Load Combinations
C1A.1	Infrequent Surge + Wave + Impervious Uplift	Service (Unusual)	1	$1.6 (D + EH + EV + Hs_N + Hw_N)$
C1A.2	Infrequent Surge + Wave + Pervious Uplift	Service (Unusual)	2	$1.6 (D + EH + EV + Hs_N + Hw_N)$
C1B.1	Maximum Surge + Wave + Impervious Uplift	Strength	3	$1.2 D + 1.5 EH_A - 0.5 EH_P + 1.35 EV + 1.3(1.0(Hs_X + Hw_X))$
			4	$1.2 D + 1.5 EH_A - 0.5 EH_P + 1.00 EV + 1.3(Hs_X + Hw_X)$
			5	$0.9 D + 1.5 EH_A - 0.5 EH_P + 1.35 EV + 1.3(Hs_X + Hw_X)$

			6	$0.9 D + 1.5 E_{H_A} - 0.5 E_{H_P} + 1.00 EV + 1.3(H_{s_X} + H_{w_X})$
C1B.2	Maximum Surge + Wave + Pervious Uplift	Strength	7	$1.2 D + 1.5 E_{H_A} - 0.5 E_{H_P} + 1.35 EV + 1.3(H_{s_X} + H_{w_X})$
			8	$1.2 D + 1.5 E_{H_A} - 0.5 E_{H_P} + 1.00 EV + 1.3(H_{s_X} + H_{w_X})$
			9	$0.9 D + 1.5 E_{H_A} - 0.5 E_{H_P} + 1.35 EV + 1.3(H_{st_X} + H_{w_X})$
			10	$0.9 D + 1.5 E_{H_A} - 0.5 E_{H_P} + 1.00 EV + 1.3(H_{s_X} + H_{w_X})$
C2A	Coincident Pool + OBE	Service (Unusual)	11	(exempt)
C2B	Coincident Pool + MCE	Strength	12	(exempt)
C3	Construction	Service (Unusual)	13	$1.6 (D + EH + EV + ES)$
C4	Normal Operating	Service (Usual)	14	$2.2(D + EH + EV + H_s + H_{w_U})$
C5.1	Maximum differential head + Impact + Impervious Uplift	Strength	15	$1.2 D + 1.5 E_{H_A} - 0.5 E_{H_P} + 1.35 EV + 1.3(H_{s_X} + B_{I_X})$
			16	$1.2 D + 1.5 E_{H_A} - 0.5 E_{H_P} + 1.00 EV + 1.3(H_{s_X} + B_{I_X})$
			17	$0.9 D + 1.5 E_{H_A} - 0.5 E_{H_P} + 1.35 EV + 1.3(H_{s_X} + B_{I_X})$
			18	$0.9 D + 1.5 E_{H_A} - 0.5 E_{H_P} + 1.00 EV + 1.3(H_{s_X} + B_{I_X})$
C5.2	Maximum differential head + Impact + Impervious Uplift	Strength	19	$1.2 D + 1.5 E_{H_A} - 0.5 E_{H_P} + 1.35 EV + 1.3(H_{s_X} + B_{I_X})$
			20	$1.2 D + 1.5 E_{H_A} - 0.5 E_{H_P} + 1.00 EV + 1.3(H_{s_X} + B_{I_X})$
			21	$0.9 D + 1.5 E_{H_A} - 0.5 E_{H_P} + 1.35 EV + 1.3(H_{s_X} + B_{I_X})$
			22	$0.9 D + 1.5 E_{H_A} - 0.5 E_{H_P} + 1.00 EV + 1.3(H_{s_X} + B_{I_X})$

Step 2. Determine  $M_u$  and  $V_u$  for Wall Stem. Weight of stem is neglected. The predetermined governing load case is C1B and the resulting factored loads are shown below and are per foot length of wall.

Table D-4. Factored Loads for the Predetermined Governing Load Case C1B.

Load Type	Horiz. Load	Moment Arm	Moment
F.S. HT <sub>2</sub> :	30.71 kips	9.04 ft	278 k-ft
P.S. HT <sub>2</sub> :	-4.54 kips	3.48 ft	-15.8 k-ft
F.S. Lateral Earth, EH:	0.27 kips	0.78 ft	0.21 k-ft
P.S. Lateral Earth, EH:	-0.09 kips	0.78 ft	-0.07 k-ft
Wave Load, WA:	8.01 kips	16.96 ft	136 k-ft
Resulting Loads at Base of Stem:	34.36 kips		398 k-ft

$$V_u = 34.36 \text{ Kips } M_u = 398 \text{ k-ft}$$

Step 3. Determine Wall Stem Thickness and Reinforcement.

Assume a trial thickness,  $h$ . Try  $\ell/8$ , which is minimum for non-prestressed cantilever beams.

$$h = \frac{((28.33 \text{ ft})(12 \text{ in/ft}))}{8} = 42 \text{ in}$$

Assume:  $f'_c = 4000 \text{ psi}$   
 $f_y = 60,000 \text{ psi}$   
 $b_w = 12 \text{ in.}$   
 $\Phi = 0.75$   
 $\lambda = 1.0.$

Validate if the wall thickness is adequate for shear at base of stem. It must satisfy  $\Phi V_c \geq V_u$ .

Compute  $d$ :  $d = h - \text{cover} - 0.5(\text{bar diameter})$

Assume max bar diameter #18 bars,  $d_b = 2.257 \text{ in.}$

$$d = 42 \text{ in.} - 4 \text{ in.} - 0.5(2.257 \text{ in.}) = 36.872 \text{ in.}$$

Use:  $d = 36.5 \text{ in.}$

Compute  $d_d$ :

$$M_n = \frac{M_u}{\Phi} = \frac{398}{0.9} = 442 \text{ k-ft}$$

From Table D-1:



$$d_d = \sqrt{\frac{2.4956M_n}{b_w}} = \sqrt{\frac{2.4956(442)(12)}{12}} = 33.21 \text{ in.}$$

$d > d_d$ , therefore stem width is adequate.

Determine if  $\Phi V_c \geq V_u$ .

$$V_c = 2\lambda\sqrt{f'_c}b_wd$$

$$V_c = \frac{2(1.0)\sqrt{4000}(12)(36.5)}{1000} = 55.4 \text{ kips}$$

$$\Phi V_c = 0.75(55.4) = 41.6 \text{ kips}$$

41.6 kips  $\geq$  34.4 kips, thus  $\Phi V_c \geq V_u$

Compute  $A_s$ :

$$K_u = 1 - \sqrt{1 - \frac{M_n + P_n \left(d - \frac{h}{2}\right)}{0.425f'_cb_wd^2}}$$

$$K_u = 1 - \sqrt{1 - \frac{442(12)}{0.425(4)(12)(36.5^2)}} = 0.103$$

$$A_s = \frac{0.85f'_cK_ub_wd}{f_y} = \frac{0.85(4)(0.103)(12)(36.5)}{60} = 2.56 \text{ sq. in.}$$

Try No. 11 bars,  $A_{11} = 1.56$  sq. in.

$$s = \frac{A_{11}}{A_s}b_w = \frac{1.56}{2.56}(12) = 7.31 \text{ in.}$$

Use No. 11 bars @ 7 in. center to center, both faces.

Step 4. Determine Embedment Depth into Base Slab.

It is recommended to fully develop the tension reinforcement of the wall into the base slab. Based on this development length, the base slab should be sized so that this development length can be achieved.

Per ACI 318:

It may not be economically feasible to develop the vertical tension steel (no bends) within the required base slab depth. Thus, it is recommended to hook the bars, 90 or 180 degrees. The direction of the hook should always be faced in unless confinement reinforcement is used.

$$l_{dh} = \frac{0.02f_y\psi_e}{\lambda\sqrt{f'_c}} d_b = \frac{0.02(60,000)(1.0)}{(1.0)\sqrt{4000}} (1.41) = 18.97 \text{ in.}$$

ACI 318 permits a reduction if side cover is not less than 2.5 in. and clear cover beyond hook not less than 2 in.

$$0.7l_{dh} = 0.7(18.97) = 13.28 \text{ in.}$$

Use a minimum embedment depth from the base of the stem to a distance 14 in. below. Typically, the hooks will rest on the bottom mat and be tied to the top mat of reinforcement in the base slab. Thus, when designing the base slab, it is important to match the reinforcement spacing of the vertical bars.

Step 5. Determine Temperature and Shrinkage Reinforcement for Stem.

Per Section 2.8:

$$A_{T\&S} = \frac{0.005A_g}{2} \leq 1.00 \text{ sq. in., .ea. face}$$

$$A_{T\&S} = \frac{0.005(504)}{2} = 1.26 \text{ sq. in.}$$

Since greater than maximum allowed, use #9 bars @ 12 in. c.c. spacing each face.

Step 6. Since the wall is tall, it may be feasible and economical to transition the vertical reinforcement to a smaller bar size near the top. ACI permits a reduction as long as the steel provided is 1/3 greater than required by analysis.

Compute moment per foot length of wall:

$$a = \frac{A_s f_y}{0.85 f'_c b} = \frac{1.56(60,000)}{0.85(4000)(7)} = 3.93$$

$$\begin{aligned} \phi M_n &= \phi 0.85 f'_c a b \left( d - \frac{a}{2} \right) = \frac{0.90(0.85)(4000)(3.93)(7) \left( 36.5 - \frac{3.93}{2} \right)}{(1000)(12)} \\ &= 242 \text{ k} - \text{ft} \end{aligned}$$

Determine equivalent moment arm (11.64 ft.) and resulting lateral load (25.67 kips/ft).

Calculate moment per bar spacing along the length of wall using the values in Table D-5.

Table D-5. Calculations of Moment per Bar Spacing along the Length of Wall.

EL	z	$\Phi M_{nz}$	$A_{s,reqd}$	$1.33A_{s,reqd}$
-12.33	28.33	242	2.024	2.698
-12	28	234	1.954	2.605
-11	27	210	1.752	2.336
-10	26	187	1.565	2.086
-9	25	167	1.391	1.854
-8	24	147	1.231	1.640
-7	23	130	1.083	1.444
-6	22	114	0.948	1.264
-5	21	99	0.824	1.099
-4	20	85	0.712	0.949
-3	19	73	0.611	0.814
-2	18	62	0.519	0.692
-1	17	52	0.437	0.583
0	16	44	0.365	0.486
1	15	36	0.300	0.401
2	14	29	0.244	0.326
3	13	23	0.196	0.261
4	12	18	0.154	0.205
5	11	14	0.118	0.158
6	10	11	0.089	0.119
7	9	8	0.065	0.087
8	8	5	0.046	0.061
9	7	4	0.031	0.041
10	6	2	0.019	0.026
11	5	1	0.011	0.015
12	4	1	0.006	0.008
13	3	0	0.002	0.003
14	2	0	0.001	0.001
15	1	0	0.000	0.000
16	0	0	0.000	0.000

A good rule of thumb is to consider reducing the reinforcement size when  $1.33A_s$  results in an area reduction of ~50%. Therefore, at EL. -2, 0.692 sq. in. is required. A No. 8 bar would satisfy this requirement.

Another cost saving option not covered under this example would be to taper the wall.

Step 7. Determine Base Slab Thickness and Reinforcement.

The global pile reactions determined using CPGA\* and input into a 2D STAAD model with a strip width based on the pile spacing. The governing load case was determined to be C1B.2, Load Combination No. 9 for shear and No. 10 for flexure. Table D-6 lists factored loads were determined based on a pile spacing of 6 ft.

Table D-6. Factored Loads Determined Based on a Pile Spacing of 6 ft.

Load Case	Load No.	$M_u$	$V_u$
C1A.1	1	1816 k-ft	256 kips
C1A.2	2	2248 k-ft	275 kips
C1B.1	3	2101 k-ft	268 kips
	4	2100 k-ft	268 kips
	5	2235 k-ft	282 kips
	6	2235 k-ft	282 kips
C1B.2	7	2526 k-ft	318 kips
	8	2528 k-ft	317 kips
	9	2661 k-ft	332 kips
	10	2663 k-ft	331 kips
C2A	11	Exempt	
C2B	12	Exempt	
C3	13	837 k-ft	137 kips
C4	14	811 k-ft	129 kips
C5.1	15	1758 k-ft	234 kips
	16	1759 k-ft	233 kips
	17	1892 k-ft	247 kips
	18	1884 k-ft	245 kips
C5.2	19	2212 k-ft	286 kips
	20	2179 k-ft	281 kips
	21	2346 k-ft	300 kips
	22	2346 k-ft	300 kips

Max Factored Loads:  $M_u = 2663$  k-ft  
 $V_u = 332$  kips.

Follow the same design procedure used for the stem with the exception of,  $b_w = 72$  in.

---

\* A computer program for basic pile group analysis, CPGA, developed through the Computer-Aided Structural Engineering (CASE) Project by the Task Group on Pile Structures and Substructures (Hartman et al. 1989).

The bottom mat should be 3” clear from the top of the embedded pile if the pile head is designed as pinned. The reason for this is to account for vertical pile driving tolerances. For guidance on pile head anchoring and embedment, refer to EM 1110-2-2906.

D.7. Shear Strength Example for Special Straight Members.

Paragraph 5.2 describes the conditions for which a special shear strength criterion shall apply for straight members. The following example demonstrates the application of Equation 5-1. Figure D-7 shows a rectangular conduit with factored loads,  $2.2(D + EH + EV)$ . The following parameters are given or computed for the roof slab of the conduit.

$$f'_c = 4,000 \text{ psi}$$

$$l_n = 10.0 \text{ ft} = 120 \text{ in.}$$

$$d = 2.0 \text{ ft} = 24.0 \text{ in.}$$

$$b = 1.0 \text{ ft (unit width)} = 12 \text{ in.}$$

$$N_u = 6.33 (5) = 31.7 \text{ kips}$$

$$A_g = 2.33 \text{ sq. ft} = 336 \text{ sq. in.}$$

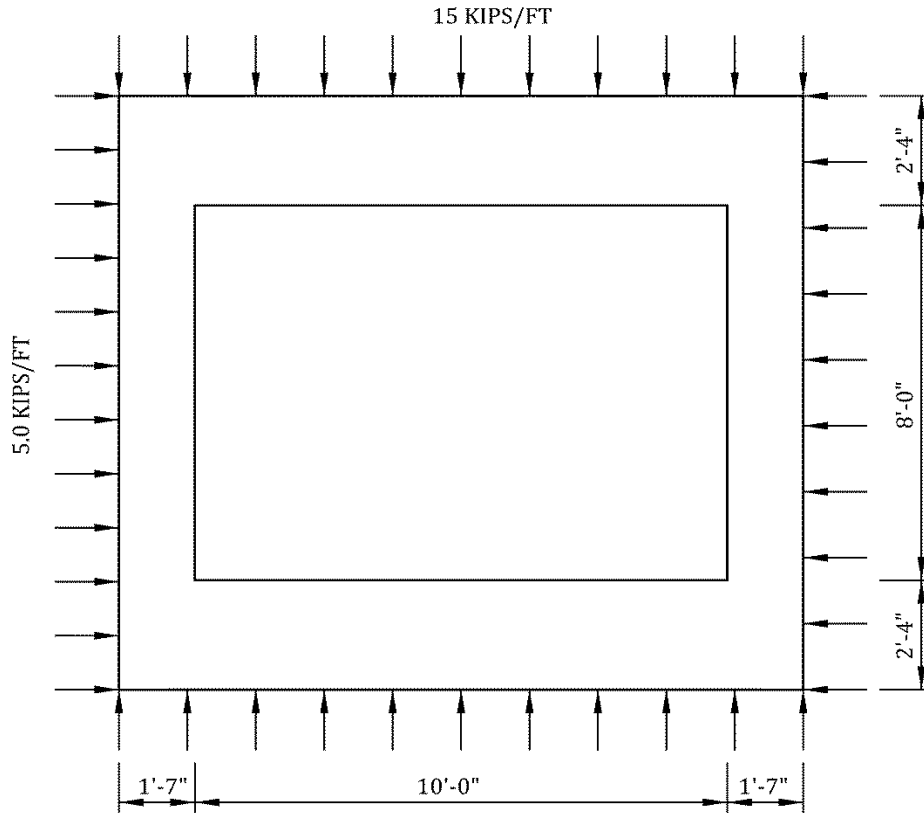

Figure D-7. Rectangular Conduit.

Calculate  $V_c$  using Equation 5-2 from Chapter 5:

$$V_c = \left[ \left( 11.5 - \frac{120 \text{ in.}}{24 \text{ in.}} \right) \sqrt{4,000} \sqrt{1 + \left( \frac{31,700 \text{ lb}}{336 \text{ in}^2} \right)} \right] (12 \text{ in.})(24 \text{ in.})$$

$$V_c = 134,906 \text{ lb} = 134.9 \text{ kips}$$

Check limit:  $V_c = 10\sqrt{f'_c}bd = 10\sqrt{4,000}(12 \text{ in.})(24 \text{ in.}) = 182,147 \text{ lb}$

Compare shear strength with applied shear:

$$\phi V_c = 0.75(134.9 \text{ kips}) = 101.2 \text{ kips}$$

$V_u$  at  $0.15(l_n)$  from face of the support is:

$$V_u = w \left( \frac{l_n}{2} - 0.15l_n \right)$$

$$V_u = 15 \frac{\text{kips}}{\text{ft}} \left[ \left( \frac{10 \text{ ft}}{2} \right) - 0.15(10 \text{ ft}) \right] = 52.5 \text{ kips} \leq \phi V_c; \text{ shear strength is adequate}$$

D.8. Shear Strength Example for Curved Members.

Paragraph 5.3 described the conditions for which Equation 5-3 shall apply. The following example applies Equation 5-3 to the circular conduit presented in Figure D-8. Factored loads are shown, and the following values are given or computed:

$$f'_c = 4,000\text{psi}$$

$$b = 12\text{ in.}$$

$$d = 43.5\text{ in.}$$

$$A_g = 576\text{ sq. in}$$

$$N_u = 162.5\text{ kips}$$

$$V_u = 81.3\text{ kips at a section 45 degrees from crown.}$$

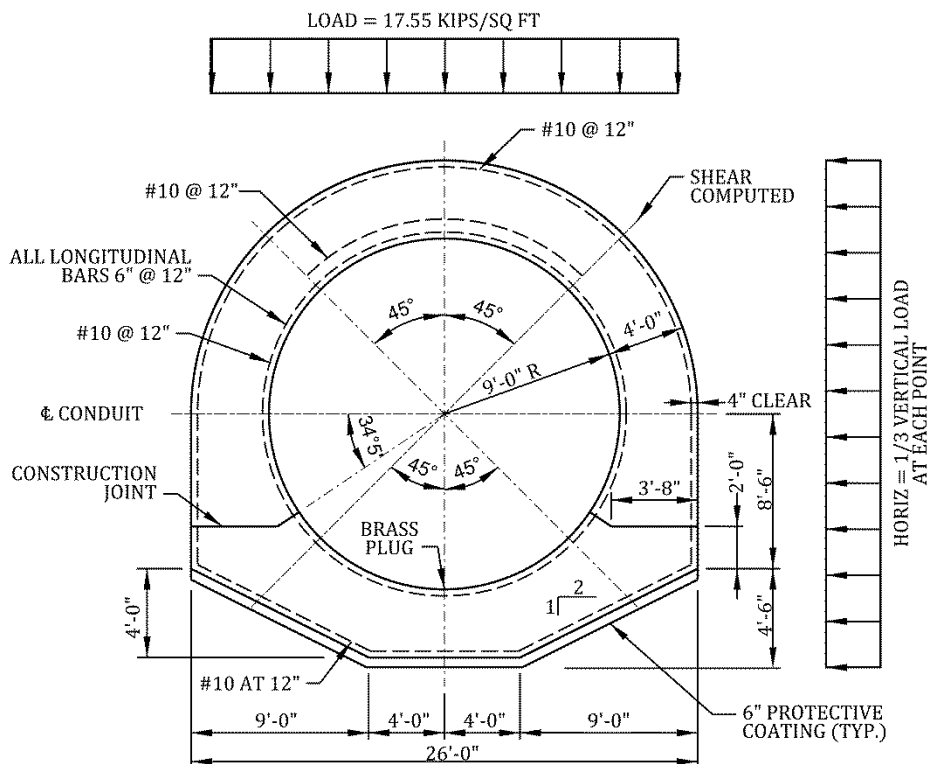

Figure D-8. Circular Conduit.

Calculate  $V_c$  using Equation 5-3 from Chapter 5:

$$V_c = 4\sqrt{4,000} \left[ \sqrt{1 + \left( \frac{162,500 \text{ lb}}{576 \text{ in}^2} \right)} \right] (12 \text{ in.})(43.5 \text{ in.})$$

$$V_c = 192,058 \text{ lb} = 192.1 \text{ kips}$$

Check limit:  $V_c = 10\sqrt{f'_c}bd = 10\sqrt{4,000}(12 \text{ in.})(43.5 \text{ in.}) = 330,142 \text{ lb}$

Compare the strength with the applied shear:

$$\phi V_c = 0.75(192.1 \text{ kips}) = 144.1 \text{ kips}$$

$V_u \leq \phi V_c$  ; shear strength is adequate.



## APPENDIX E

### Load Combinations for Design of Typical Reinforced Concrete Hydraulic Structures

E.1. Purpose. This appendix provides load description, load category, load factors, and load case combination for typical concrete hydraulic structures as described in Chapter 3. The load case combination described should be used as a guide. Other combinations may be required based on site specific conditions.

E.2. Retaining Wall. (Normal Structure)

Table E-1. Load Combinations for a Retaining Wall.

Load Case	Load Description	Load Category	Factored Loads
R1	Normal Operating	Usual	$2.2(D + EH + EV + H_{sU})$
R2A	Normal Operating + Surge	Unusual	$1.6(D + EH + EV + H_{sU} + ES_N)$
R2B	Normal Operating + Short Duration Water Load	Unusual	$1.6(D + EH + EV + H_{sN})$
R3A	Normal Operating + OBE	Unusual	$1.5(D + EH + EV + H_{sU} + EQ)$
R3B	Normal Operating + MDE	Extreme (Strength)	$(1.2 \text{ or } 0.9)D + (1.5 \text{ or } 0.5)EH + (1.35 \text{ or } 1.0)EV + 1.0 H_{sU} + 1.25EQ$
R4	Normal Operating + Maximum Water	Extreme (Strength)	$(1.2 \text{ or } 0.9)D + (1.5 \text{ or } 0.5)EH + (1.35 \text{ or } 1.0)EV + 1.3H_{sX}$

E.2.1. Loading Condition R1, Normal Operating.

- Backfill is placed to the final elevation (the backfill is dry, moist, or partially saturated as the case may be).
- Normal lateral and uplift water pressures.

E.2.2. Loading Condition R2A, Normal Operating + Surge Loads. This case is the same as R1 except a temporary surge is applied.

E.2.3. Loading Condition R2B, Normal Operating + Short Duration Loads. This case is the same as R1 except the water table level in the backfill rises or water on the resisting side lowers, on a temporary basis with an AEP between 1/10 and 1/300.

E.2.4. Loading Condition R3A, Normal Operating + OBE. This is the same as Case R1 except with the addition of OBE-induced lateral and vertical loads. The uplift is the same as for Case R1.

E.2.5. Loading Condition R3B, Normal Operating + MDE. This is the same as Case R1 except with the addition of MDE induced lateral and vertical loads. The uplift is the same as for Case R1. The equation in table assumes that standard ground motions are used.

E.2.6. Loading Condition R4, Normal Operating + Maximum Water Load. This case is the same as R1 except the water table level in the backfill rises to the maximum expected level or the resisting side lowers to a minimum level on a temporary basis with expected return period greater than 300 years.

E.3. Inland Floodwall. (Critical Structure)

Table E-2. Load Combinations for an Inland Floodwall.

Load Case	Load Description	Load Category	Factored Loads
I1	Infrequent Flood	Unusual	$1.6(D + EH + EV + H_{SN})$
I2	Maximum Hydraulic Head	Extreme (Strength)	$(1.2 \text{ or } 0.9)D + (1.5 \text{ or } 0.5)EH + (1.35 \text{ or } 1.0)EV + 1.3H_{SX} + 1.0H_{WU}$
I3A	Coincident Pool + OBE	Unusual	$1.5(D + EH + EV + H_s + EQ)$
I3B	Coincident Pool + MDE	Extreme (Strength)	$1.0D + 1.0EH + 1.0EV + 1.0H_s + 1.0EQ$
I4	Construction	Unusual	$1.6(D + EH + EV + ES_N)$

E.3.1. Loading Condition I1, Infrequent Flood.

- Backfill in place to final elevation.
- Water at an elevation of interest for the project. Frequently the 100-yr flood or project design event.
- Any lateral soil pressure or weight of soil that may be present.
- Uplift.

E.3.2. Loading Condition I2, Maximum Hydraulic Head.

- Combination of water on the protected and unprotected side, which produces the maximum structural loading condition, with any AEP.
- Any lateral soil pressure or weight of soil that may be present. Load factors shown assume structure has movement in this load case.
- Uplift.
- Wave force from a wind event with 10-year return period.

E.3.3. Loading Condition I3A, Coincident Pool + OBE. (Note: This load case need only be considered if the wall has a significant loading during the non-flood stage.)

- Backfill in place to final elevation.
- Water, if applicable, is at an elevation that is coincident with mean annual non-flood operating conditions.
- Dead load, lateral soil pressure, and weight of soil that may be present.
- Uplift, if applicable.
- OBE-induced lateral and vertical loads.

E.3.4. Loading Condition I3B, Coincident Pool + MDE. (Note: This load case need only be considered if the wall has a significant loading during the non-flood stage.)

- Backfill in place to final elevation.

- Water, if applicable, is at an elevation that is coincident with mean annual non-flood operating conditions.
- Uplift, if applicable.
- Dead load, lateral soil pressure, and weight of soil that may be present.
- MCE-induced lateral and vertical loads.
- Critical structure (MDE=MCE) with site specific ground motion determination.

E.3.5. Loading Condition I4, Construction Condition.

- Floodwall is in place with the loads added that are possible during the construction period.

E.4. Coastal Floodwall. (Critical Structure).

Table E-3. Load Combinations for a Coastal Floodwall.

Load Case	Load Description	Load Category	Factored Loads
C1A	Infrequent Surge + Wave	Unusual	$1.6(D + EH + EV + H_{sN} + H_{wN})$
C1B	Maximum Surge + Wave	Extreme (Strength)	$(1.2 \text{ or } 0.9)D + (1.5 \text{ or } 0.5)EH + (1.35 \text{ or } 1.0)HV + 1.3(H_{sX} + H_{wX})$
C2A	Coincident Pool + OBE	Unusual	$1.5(D + EH + EV + H_s + EQ)$
C2B	Coincident Pool + MDE	Extreme (Strength)	$1.0D + 1.0EH + 1.0EV + 1.0H_s + 1.0EQ$
C3	Construction	Unusual	$1.6(D + EH + EV + E_{sN})$
C4	Normal Operating	Usual	$2.2(D + EH + EV + H_{sU} + H_{wU})$
C5	Maximum differential head + Impact	Extreme (Strength)	$(1.2D \text{ or } 0.9)D + (1.5 \text{ or } 0.5)EH + (1.35 \text{ or } 1.0)EV + 1.3(H_{sX} + B_{IX})$

E.4.1. Loading Condition C1A, Design Surge Stillwater + Coincident Wave Force.

- Design surge still water condition + the governing nonbreaking, breaking, or broken wave conditions coincident with the design surge still water condition.
- Dead load, lateral soil pressure, and weight of soil that may be present.
- Uplift is acting, based on the surge still water.

E.4.2. Loading Condition C1B, Maximum Surge Stillwater + Coincident Wave Force.

- Maximum considered possible force or moment from surge still water condition + the nonbreaking, breaking, or broken wave conditions coincident with that condition.
- Uplift, based on the surge still water.

E.4.3. Loading Condition C2A, Coincident Pool+ OBE.

- Water at level representing mean annual tide pool conditions.
- Uplift, if applicable.

- OBE-induced lateral and vertical loads, if applicable.

E.4.4. Loading Condition C2B, Coincident Pool + MDE.

- Same as condition C2A, except use MDE (Equal to MCE for a critical structure).
- Critical structure with site specific ground motion determination.

E.4.5. Loading Condition C3, Construction.

- Floodwall is in place with the loads added, which are possible during the construction period, but are of short duration.

E.4.6. Loading Condition C4, Normal Operating.

- Water is at the highest level with 10-year return period on the unprotected side.
- Wave force from a wind event with 10-year return period.
- Uplift is acting.

E.4.7. Loading Condition C5, Maximum differential head + Aberrant Barge or Boat Impact.

- Maximum considered possible differential head condition.
- Vessel impact coincident with the maximum differential head condition. Vessel impact and water level are correlated.
- Uplift is acting, based on the maximum differential head.

E.5. Intake Tower. (Normal Structure).

Table E-4. Load Combinations for an Intake Tower.

Load Case	Load Description	Load Category	Factored Loads
1A	Normal Pool, All Gates Open	Usual	$2.2(D + EH + EV + Hs_U + Hw_U)$
1B	Normal Pool, One or more Gates Closed	Usual	$2.2(D + EH + EV + Hs_U + Hw_U)$
1C	Normal Pool, All Gates Closed	Usual	$2.2(D + EH + EV + Hs_U + Hw_U)$
1D	Normal Pool with Silt	Usual	$2.2(D + EH + EV + Hs_U + Hw_U)$
2	Minimum Pool	Usual	$2.2(D + EH + EV + Hs_U + Hw_U)$
3A	Infrequent Flood, All Gates Open	Unusual	$1.6(D + EH + EV + Hs_N + Hw_U \text{ or } IM_U)$
3B	Infrequent Flood, One or more Gates Closed	Unusual	$1.6(D + EH + EV + Hs_N + Hw_U \text{ or } IM_U)$
3C	Infrequent Flood, All Gates Closed	Unusual	$1.6(D + EH + EV + Hs_N + Hw_U \text{ or } IM_U)$
4	Construction	Unusual	$1.6(D + EH + EV + ES_N + W_U)$
5	Diversion	Unusual	$1.6(D + EH + EV + ES_N + Hs_U + W_U)$

Table E-4. Load Combinations for an Intake Tower (Continued).

Load Case	Load Description	Load Category	Factored Loads
6	Maintenance Bulkheads in Place	Unusual	$1.6(D + EH + EV + H_{sN})$
7A	OBE + Coincident Pool	Unusual	$1.5(D + EH + EV + H_{sU} + EQ)$
7B	MDE + Coincident Pool	Extreme (Strength)	$1.0D + 1.0EH + 1.0EV + 1.0 H_{sU} + 1.0EQ$
8	MDF	Extreme (Strength)	$(1.2D \text{ or } 0.9)D + (1.5 \text{ or } 0.5)EH + (1.35 \text{ or } 1.0)EV + 1.3(H_{sX})$
9A	Maximum Wave	Extreme (Strength)	$(1.2D \text{ or } 0.9)D + (1.5 \text{ or } 0.5)EH + (1.35 \text{ or } 1.0)EV + 1.0H_{sU} + 1.0(H_{wX})$
9B	Maximum Ice	Extreme (Strength)	$(1.2D \text{ or } 0.9)D + (1.5 \text{ or } 0.5)EH + (1.35 \text{ or } 1.0)EV + 1.0H_{sU} + 1.3(IX_X \text{ or } IM_X)$

E.5.1. Loading Condition 1A, Normal Pool, All Gates Open.

- Dead load of structure.
- Reservoir at normal pool.
- Earth load (if any).
- Wave force from a wind event with 10-year return.
- Uplift.
- Water surface inside structure drawn down to hydraulic gradient with all gates fully opened.

E.5.2. Loading Condition Case No.1B, Normal Pool, One or More Gates Closed.

- Dead load of structure.
- Reservoir at normal pool.
- One or more gates closed with other gates fully opened and water surface drawn down to hydraulic gradient in remainder of structure in combinations that produce the most unstable conditions.
- Earth load (if any).
- Uplift.
- Wet-well full of water upstream from closed gate.
- Wave force from a wind event with 10-year return.

E.5.3. Loading Condition 1C, Normal Pool, All Gates Closed.

- Dead load of structure.
- Reservoir at normal pool.

- Earth load (if any).
- Uplift.
- Wave force from a wind event with 10-year return.

E.5.4. Loading Condition 1D, Normal Pool with Silt.

- Reservoir with silt for the most critical of proceeding conditions U1 through U3.

E.5.5. Loading Condition 2, Minimum Pool.

- Reservoir empty or at minimum pool.
- Dead load of structure.
- Earth load (if any).
- Wind load in the direction that would produce the most severe foundation pressures.
- Uplift.
- Wave force from a wind event with 10-year return.

E.5.6. Loading Conditions 3A through 3C.

- Loading conditions UN1 through UN3 are the same as U1 through U3 except the reservoir, rather than being at the normal pool condition, is at the infrequent flood stage, i.e., it is at an elevation representing a flood event with return period as high as 300 years. Ice load can be included if it is a serviceability concern.

E.5.7. Loading Condition 4, Construction.

- Reservoir empty.
- Dead load of structure (partially or fully completed).
- Earth load (if any).
- Heavy construction equipment required on or near the structure during construction.
- Wind load in the direction that would produce the most severe foundation pressures determined using ASCE 7 serviceability criteria (Unusual return period of 100 years).

E.5.8. Loading Condition 5, Diversion.

- Reservoir at maximum elevation expected during diversion.
- Dead load of structure at diversion level completion.
- Earth load (if any).
- Heavy construction equipment required on or near the structure.

- Wind load in the direction that would produce the most severe foundation pressures, determined using ASCE 7 serviceability criteria with a wind event with 10-year return period.

E.5.9. Loading Condition 6, Maintenance Bulkheads in Place.

- Bulkheads in place, no water in structure downstream of bulkheads.
- Dead load of structure.
- Reservoir at maximum pool level at which bulkheads are used.
- Earth loads (if any).
- Uplift.

E.5.10. Loading Condition 7A, Coincident Pool + OBE.

- OBE for the most critical of the conditions U1 through U5 with the reservoir at the coincident pool elevation.

E.5.11. Loading Condition 7B, Coincident Pool + MDE.

- MDE for the most critical of the conditions U1 through U5 with the reservoir at the coincident pool elevation. The equation in table assumes site specific ground motion is used.

E.5.12. Loading Condition 8, MDF.

- Pool at PMF elevation.
- All gates opened or closed, depending on project operating criteria.

E.5.13. Loading Condition 9A, Maximum Wave.

- Pool at elevation with 10-year return period.
- Gates at normal settings (multiple setting if needed).
- Wave load from wind event of 3,000-year return period.

E.5.14. Loading Condition 9B, Maximum Ice.

- Pool at elevation with 10-year return period.
- Gates at normal settings during ice season.
- Upper bound Ice Load (return period unknown).

E.6. Navigation Lock Wall. (Normal Structure).

Table E-5. Load combinations for a Navigation Lock Wall.

Load Case	Load Description	Load Category	Factored Loads
1A	Normal Operating, Empty	Usual	$2.2(D + EH + EV + Hs_U + BI_U)$
1B	Normal Operating, Filled	Usual	$2.2(D + EH + EV + Hs_U + BI_U)$
1A1, 1B1	Normal Operating, Hawser	Unusual	$1.6(D + EH + EV + Hs_U + HA)$
2A	Extreme Low Water	Extreme (Strength)	$(1.2 \text{ or } 0.9)D + (1.35 \text{ or } 0.9)EH + (1.35 \text{ or } 1.0)EV + 1.3Hs_X$
2B	Maintenance	Unusual	$1.6(D + EH + EV + Hs_N)$
2C	Coincident Pool + OBE	Unusual	$1.5(D + EH + EV + Hs_U + EQ)$
2D	Coincident Pool + MDE	Strength	$1.0D + 1.0EH + 1.0EV + 1.0Hs_U + 1.0EQ$
3	Construction	Unusual	$1.6(D + EH + EV + ES_N + W_U)$

E.6.1. Loading Condition 1A, Normal Operating Condition.

- • Backfill loads (soil, water, and surcharge).
- • Lower pool in landward lock chamber, upper pool in riverward lock chamber.
- • Uplift as defined by water elevations.
- • Vessel impact (Usual with 10-year return period), if additive to forces.

E.6.2. Loading Condition 1B, Normal Operating Condition.

- Loads (soil, water, and surcharge). Backfill.
- Upper pool in landward lock chamber, lower pool in riverward lock chamber.
- Uplift as defined by water elevations.
- Vessel impact (mean annual impact force), if additive to forces.

E.6.3. Loading Condition 1A1, Normal Operating Condition with Unusual Hawser Load.

- Backfill loads (soil, water, and surcharge).
- Hawser load.
- Lower pool in landward lock chamber, upper pool in riverward lock chamber.
- Uplift as defined by water elevations.

E.6.4. Loading Condition 1B1, Normal Operating Condition with Unusual Hawser Load.

- Loads (soil, water, and surcharge). Backfill.
- Hawser load.
- Upper pool in landward lock chamber, lower pool in riverward lock chamber.
- Uplift as defined by water elevations.



E.6.5. Loading Condition 2a, Operating Condition with Drawdown.

- The same requirements for Conditions 1A and 1B are included except water is at extreme low water stage for lower pool.
- Soil Pressures in the equation assume a very stiff structure with little movement and at-rest lateral earth pressures.

E.6.6. Loading Condition 2B, Maintenance Condition. The same requirements for Conditions 1A and 1B are included except for the following conditions:

- Lock chamber unwatered to a predetermined level.

E.6.7. Loading Condition 2C, Normal Operating + OBE.

- The same requirements for Conditions 1A and 1B except for the condition of an OBE earthquake load added in the most critical direction.

E.6.8. Loading Condition 2D, Normal Operating + MDE.

- The same requirements for Conditions 1A and 1B except for the condition of an MDE earthquake load added in the most critical direction. The equation shown assumes a site specific ground motion is used.

E.6.9. Loading Condition 3, Construction Conditions.

- Backfill loads (soil and surcharge).
- Wind as applicable determined using ASCE 7 serviceability criteria (Unusual with 100-year return period).
- No uplift.
- Hydrostatic forces are active in accordance with construction or cofferdam plans.

E.7. Navigation Lock Gate Monolith. (Normal Structure).

Table E-6. Load Combinations for a Navigation Lock Gate Monolith.

Load Case	Load Description	Load Category	Factored Loads
1A	Normal Operating, Gates Loaded	Usual	$2.2(D + EH + EV + H_{sU})$
1B	Normal Operating, Gates Unloaded	Usual	$2.2(D + EH + EV + H_{sU})$
1C	Normal Operating, Gates Operating	Usual	$2.2(D + EH + EV + H_{sU} + Q_U)$
2A	Extreme Low Water	Extreme (Strength)	$(1.2 \text{ or } 0.9)D + (1.35 \text{ or } 0.9)EH + (1.35 \text{ or } 1.0)EV + 1.3H_{sX}$
2B	Maintenance	Unusual	$1.6(D + EH + EV + H_{sN})$
2C & 2D	1A & 1B + OBE	Unusual	$1.5(D + EH + EV + H_{sU} + EQ)$
2E & 2F	Coincident Pool + MDE	Extreme (Strength)	$1.0D + 1.0EH + 1.0EV + 1.0 H_{sU} + 1.0EQ$
3	Construction	Unusual	$1.6(D + EH + EV + ES_N)$

E.7.1. Loading Condition 1A, Normal Operating Condition.

- Upper pool upstream of gates.
- Lower pool downstream of gates.
- Head differential with less than 10-year return.
- Applicable wall loadings.

E.7.2. Loading Condition 1B, Normal Operating Condition.

- Gates closed.
- For upper gate bay, upper pool in gate bay.
- For lower gate bay, lower pool in lock chamber.
- Head differential with less than 10-year return.
- Applicable wall loadings.

E.7.3. Loading Condition 1C, Normal Operating Condition, Gates Operating.

- Reactions from gate operation.
- For upper gate bay, upper pool in gate bay.
- For lower gate bay, lower pool in lock chamber.
- Pool level with less than 10-year return period.
- Applicable wall loadings.

E.7.4. Loading Condition 2A, Operating Conditions with Extreme Low Water. The same requirements for conditions 1A and 1B except for the following conditions:

- Pool in lock chamber or lock entrance, with extreme low tailwater stages.
- Uplift as defined by water elevations.
- Soil Pressures in the equation assume a very stiff structure with little movement and at-rest lateral earth pressures.

E.7.5. Loading Condition 2B, Maintenance Condition. The same requirements as for Condition 1B except for the following conditions:

- Lock chamber unwatered to a predetermined level.
- Uplift as defined by water elevations.

E.7.6. Loading Condition Case Nos. 2C and 2D, Normal Operating + OBE.

- The same requirements for Conditions 1A and 1B except for the condition of the OBE loads added in the most critical direction.

E.7.7. Loading Condition Case Nos. 2E and 2F, Normal Operating + MDE.

- The same requirements for Cases 1A and 1B except for the condition of the MDE loads added in the most critical direction.

E.7.8. Loading Condition 3, Construction Conditions.

- Moist backfill to a predetermined level.
- Permanent or construction surcharge.
- No uplift.
- Gates swinging freely in appropriate mitered position.
- Hydrostatic forces are active in accordance with construction or cofferdam plans.

E.8. Navigation Lock Approach Wall. (Normal Structure).

Table E-7. Load combinations for a Navigation Lock Approach Wall.

Load Case	Load Description	Load Category	Factored Loads
1A	Normal Operating+Vessel Impact ( $T_r < 10$ Years)	Usual	$2.2(D + EH + EV + H_{sU} + BI_U)$
1B	Normal Operating+ Vessel Impact( $T_r < 300$ Years)	Unusual	$1.6(D + EH + EV + H_{sU} + BI_N)$
1C	Normal Operating +Vessel Impact( $T_r > 300$ Years)	Extreme (Strength)	$(1.2 \text{ or } 0.9)D + (1.5 \text{ or } 0.5)EH + (1.35 \text{ or } 1.0)EV + (1.3 \text{ or } 0.8)H_{sU} + 1.3BI_X$
1D	Normal Operating,+ Vessel Thrust (Prop Wash)	Extreme (Strength)	$(1.2 \text{ or } 0.9)D + (1.5 \text{ or } 0.5)EH + (1.35 \text{ or } 1.0)EV + 1.0H_{sU} + 1.3H_{dX}$
1E	Normal Operating+ Hawser	Unusual	$1.6(D + EH + EV + H_{sU} + HA)$
2A	Normal Operating + OBE	Unusual	$1.5(D + EH + EV + H_{sU} + EQ)$
2B	Normal Operating + MDE	Extreme (Strength)	$(1.2 \text{ or } 0.9)D + (1.35 \text{ or } 0.9)EH + (1.35 \text{ or } 1.0)EV + 1.0 H_{sU} + 1.25EQ$
3	Construction	Unusual	$1.6(D + EH + EV + H_{sU} + ES_N)$

E.8.1. Loading Condition 1A, Usual Vessel Impact Loading.

- Water and backfill loads. The pool is at a level of interest for performance under routine vessel impacts. A range between low and high operational pools may be used.
- Usual vessel impact (Impact force with 10-year return period) on face of wall at most critical angle of incidence.
- Uplift as defined by water elevations.

E.8.2. Loading Condition 1B, Unusual Vessel Impact Loading.

- The same requirements as Condition 1A except that the Vessel impact is a force with 300-year return period.

E.8.3. Loading Condition Case 1C, Extreme Vessel Impact Loading.

- The same requirements as Condition 1A except that the vessel impact is a force with return period of 3,000 years.
- Normal Structure.
- Water at high operational pool with 10-year return period.

E.8.4. Loading Condition Case 1D, Vessel Thrust Loading.

- The same requirements as Condition 1C except the maximum vessel thrust load is applied. This could be considered an Unusual service load if the probability of the maximum thrust is not extremely low and/or it is desired to be able to perform under this load with highly elastic response and little cracking.

E.8.5. Loading Condition Case 1E, Hawser Loading.

- The same requirements as Condition 1B except that the Hawser Load is applied.

E.8.6. Loading Condition 2A, Normal Operating + OBE.

- Most critical normal operating condition.
- OBE loads in the most critical direction.
- No impact or hawser pull.

E.8.7. Loading Condition 2B, Normal Operating + MDE.

- Most critical normal operating condition.
- MDE loads in the most critical direction.
- No impact or hawser pull.
- Equation in table assumes standard ground motions are used.

E.8.8. Loading Condition 3, Construction Conditions.

- Temporary construction conditions exist.

E.9. Spillway Approach Channel Walls. (Critical Structure).

Table E-8. Load Combinations for Spillway Approach Channel Walls.

Load Case	Load Description	Load Category	Factored Loads
I A	Channel Empty	Usual	$2.2(D + EH + EV + H_{sU})$
I B	Channel Empty + Surge	Unusual	$1.6(D + EH + EV + H_{sU} + E_{SN})$
2	Partial Sudden Drawdown, PMF	Extreme (Strength)	$(1.2 \text{ or } 0.9)D + (1.5 \text{ or } 0.5)EH + (1.35 \text{ or } 1.0)EV + 1.0H_{sX}$
3	Sudden Pool Rise, PMF	Extreme (Strength)	$(1.2 \text{ or } 0.9)D + (1.5 \text{ or } 0.5)EH + (1.35 \text{ or } 1.0)EV + 1.0H_{sX}$
4 A	Coincident Pool + OBE	Unusual	$1.5(D + EH + EV + H_{sU} + EQ)$
4 B	Coincident Pool + MDE	Extreme (Strength)	$1.0D + 1.0EH + 1.0EV + 1.0 H_{sU} + 1.0EQ$

E.9.1. Loading Condition IA, Channel Empty, Pervious Drained Backfill Conditions.

- Channel empty.
- Backfill submerged to elevation of line of drains, and naturally drained above this elevation.
- Uplift defined by water elevations.

E.9.2. Loading Condition IB, This loading condition is same as 1A + lateral soil pressure from temporary vehicle surcharge.

E.9.3. Loading Condition 2, Partial Sudden Drawdown, Impervious Backfill Conditions.

- Partial sudden drawdown of reservoir from PMF elevation.
- Water in channel to drawdown elevation, which may occur suddenly.
- Fill submerged to profile reached during PMF, drained above.
- Uplift defined by water elevations.

E.9.4. Loading Condition 3, Sudden Rise of Reservoir, Impervious Backfill Conditions.

- Sudden rise of reservoir to PMF elevation (assumed return period > 10,000 years).
- Water in channel to PMF conditions.
- Fill submerged to concurrent water surface in fill, naturally drained above.
- Water above fill to PMF elevation.
- Uplift defined by water elevations.

E.9.5. Loading Condition 4 A, Coincident Pool + OBE.

- Coincident pool elevation.
- Backfill to predetermined height.
- Surcharge loading, if applicable.
- Uplift defined by water elevations.
- OBE loads in most critical direction.

E.9.6. Loading Condition 4 B, Coincident Pool + MDE. The same requirements as for Condition 4 A except the MDE is used instead of the OBE. The equation assumes site specific ground motions are used.

E.10. Spillway Chute Slab Walls. (Normal Structure).

Table E-9. Load Combinations for Spillway Chute Slab Walls.

Load Case	Load Description	Load Category	Factored Loads
I A	Channel Empty	Usual	$2.2(D + EH + EV + H_{sU})$
I B	Channel Empty + Surge	Unusual	$1.6(D + EH + EV + H_{sU} + E_{SN})$
2	Water in Channel, PMF	Extreme (Strength)	$1.2 \text{ or } 0.9)D + (1.5 \text{ or } 0.5)EH + (1.35 \text{ or } 0.9)EV + 1.0H_{sX}$
3 A	Coincident Pool + OBE	Unusual	$1.5(D + EH + EV + H_{sU} + EQ)$
3 B	Coincident Pool + MDE	Extreme (Strength)	$1.0D + 1.0EH + 1.0EV + 1.0 H_{sU} + 1.0EQ$

E.10.1. Loading Condition 4 B, Coincident Pool + MDE.

- The same requirements as for Condition 4 A except the MDE is used instead of the OBE. The equation assumes site specific ground motions are

E.10.2. Loading Condition I A, Channel Empty, Pervious Drained Backfill Conditions.

- Channel empty.
- Backfill submerged to elevation of drains.
- Backfill naturally drained above elevation of drains.
- Uplift defined by water elevations.

E.10.3. Loading Condition I B, Channel Empty, Pervious Drained Backfill Conditions.

- Channel empty.
- Backfill submerged to elevation of drains.
- Backfill naturally drained above elevation of drains.
- Surge loading on backfill.
- Uplift defined by water elevations.

E.10.4. Loading Condition 2, Water in Channel to PMF Elevation.

- Water in channel to PMF conditions (assumed return period > 10,000 years).
- Backfill submerged to elevation of drains.
- Backfill naturally drained above drains.
- Surge loading on backfill, if applicable.
- Uplift defined by water elevations.

E.10.5. Loading Condition 3A, Coincident Pool + OBE.

- Coincident pool elevation.
- Backfill to predetermined height.
- Surge loading, if applicable.

- Uplift defined by water elevations.
- OBE loads in most critical direction.

E.10.6. Loading Condition 3B, Coincident Pool + MDE. The same requirements as for Case 3A, except the MCE is used instead of the OBE. The equation assumes site specific ground motions are used.

E.11. Spillway Stilling Basin Walls. (Normal Structure).

Table E-10. Load Combinations for Spillway Stilling Basin Walls.

Load Case	Load Description	Load Category	Factored Loads
I	Construction or Maintenance	Unusual	$1.6(D + EH + EV + H_{sU} + ES_N)$
2	Rapid Closure of Gates	Extreme (Strength)	$(1.2 \text{ or } 0.9)D + (1.5 \text{ or } 0.5)EH + (1.25 \text{ or } 0.9)EV + 1.3H_{sX}$
3 A	Frequent Flood Discharge	Usual	$2.2(D + EH + EV + H_{sU})$
3 B	Infrequent Flood Discharge	Unusual	$1.6(D + EH + EV + H_{sN})$
3 C	Maximum Flood Discharge	Extreme (Strength)	$(1.2 \text{ or } 0.9)D + (1.5 \text{ or } 0.5)EH + (1.25 \text{ or } 0.9)EV + 1.3H_{sX}$
4 A	Coincident Pool + OBE	Unusual	$1.5(D + EH + EV + H_{sU} + EQ)$
4 B	Coincident Pool + MDE	Extreme (Strength)	$1.0D + 1.0EH + 1.0EV + 1.0 H_{sU} + 1.0EQ$

E.11.1. Loading Condition 1, Construction or Maintenance Condition.

- Stilling basin empty.
- Backfill submerged to drain or higher if, during construction or maintenance, higher elevation is anticipated with stilling basin unwatered.
- Backfill above drain naturally drained.
- Surge, if applicable.
- Uplift defined by water elevations.

E.11.2. Loading Condition 2, Rapid Closure of Gates or Reduction of Discharge of Ungated Spillway.

- Maximum reduction of discharge and tailwater, which is expected to occur rapidly.
- Water surface inside stilling basin at tailwater corresponding to reduced flow conditions.
- Backfill submerged to elevation midway between tailwater before and after reduction (corresponding to 50% reduction by drainage).
- Backfill above level of submergence naturally drained.
- Uplift of uniform intensity across the base with pressure equal to reduced hydrostatic head in backfill.

E.11.3. Loading Condition 3A, Frequent Operating Conditions, Pervious Backfill.

- Water surface inside at hydraulic jump profile frequent (Usual) discharge condition. This condition creates the greatest differential head between outside and inside faces of the wall.
- Backfill submerged to the corresponding tailwater conditions.
- Backfill above tailwater is naturally drained.
- Uplift across base varying uniformly from tailwater at heel to value midway between tailwater and jump profile at toe (the latter corresponds to 50% relief of unbalanced pressure by floor drainage).

E.11.4. Loading Condition 3 B, Infrequent Operating Conditions, Pervious Backfill.

- Water surface inside at hydraulic jump profile for an infrequent (Unusual) discharge condition of interest.
- Backfill submerged to the corresponding tailwater conditions.
- Backfill above tailwater is naturally drained.
- Uplift across base varying uniformly from tailwater at heel to value midway between tailwater and jump profile at toe (the latter corresponds to 50% relief of unbalanced pressure by floor drainage).

E.11.5. Loading Condition 3 C– Maximum Flood Operating Conditions, Pervious Backfill.

- Water surface inside at hydraulic jump profile for maximum flood discharge condition. This condition creates the greatest differential head between outside and inside faces of the wall.
- Backfill submerged to the MDF tailwater conditions.
- Backfill above tailwater is naturally drained.
- Uplift across base varying uniformly from tailwater at heel to value midway between tailwater and jump profile at toe (the latter corresponds to 50% relief of unbalanced pressure by floor drainage).

E.11.6. Loading Condition 4A, Coincident Pool + OBE.

- Coincident pool elevations.
- Backfill to predetermined height.
- Surcharge loading, if applicable.
- Uplift defined by water elevations.
- OBE loads in most critical direction.

E.11.7. Loading Condition 4 B, Coincident Pool + MDE. The requirements are the same as for Condition 4A except the MDE is used instead of the OBE. The equation assumes site specific ground motions are used.



APPENDIX F

Commentary on Chapter 3

F.1. Introduction. Table F-1 lists short discussions pertaining to content in this manual and changes made to specific sections since the 20 August 2003 version.

F.2. Discussion of Changes.

Table F-1. Summary of Changes to this Manual since the 20 August 2003 Version.

Section	Title	Comment(s)
Chapter 3		
3.1	General	The previous version of this Engineer Manual applied a hydraulic factor of 1.3 to already factored dead and live loads to provide design sections with service stresses in an acceptable range for serviceability. However, the previous version did not account for the wide variety in types of loads applied to hydraulic structures, or the need to be able to adequately and economically design for a range of load frequencies (Usual, Unusual, and Extreme). This EM separates loads and load combinations into Usual, Unusual, and Extreme categories. Usual and Unusual load categories are designed to meet serviceability goals by using strength limit states with a single load factor. The Extreme load category is designed to provide adequate reliability against exceeding strength limit states by using a Load Resistance Factor Design (LRFD).
3.1.1	ACI 318	ACI 318 is appropriate for computing member capacity; resistance factors are provided in ACI 318.
3.1.2	Serviceability Limit States	<p>For hydraulic structures, cracking, deflection, durability, vibrations, and stability are major serviceability concerns.</p> <p>Some general observations regarding the cracking phenomenon in RCHS (Liu and Gleason 1981, pp A1-A2) are that:</p> <ul style="list-style-type: none"> <li>▪ Crack widths due to applied loads are essentially proportional to the stress in the reinforcement.</li> <li>▪ Crack widths at any load level are minimized if the tension reinforcement are well distributed across the width of the concentric, concrete cross section.</li> <li>▪ Only deformed bars should be used for tension reinforcement.</li> <li>▪ The average crack width for an RCHS should not exceed 0.01 in.</li> </ul> <p>Practical methods for analyzing or predicting cracking are either very complex and costly or unreliable so accounting for crack widths and spacing is based on design experience and observed performance of RCHS. In the past, the Allowable Stress Design</p>

Section	Title	Comment(s)
		<p>methodology was used and the allowable stress for concrete members in these hydraulic structures was reduced from <math>0.45f'_c</math> to <math>0.35f'_c</math>. This reduction in allowable stress produced deeper concrete members with lower stress levels and increased reinforcing requirements. This increase in concrete depth is beneficial for hydraulic structures, which often depend on mass (more concrete) for stability, are lightly reinforced (no shear reinforcement), and are often susceptible to vibrations (mass and damping). The increased reinforcing requirements considerably help in improving crack control.</p> <p>ACI 350, <i>Code Requirements for Environmental Engineering Concrete Structures and Commentary</i>, is also concerned with limiting crack width. Crack widths in that document are managed by limiting service stresses in the reinforcing steel. LRFD strength design procedures are used with load factors adjusted to provide desired service stresses.</p> <p>The previous version of EM 1110-2-2104 used a hydraulic factor, <math>H_f</math>, to increase the total load factor used in the strength design method to achieve desired service stresses, similarly to the procedure used in ACI 350. This resulted in a single load factor method that is simple and that eliminates the necessity for separate serviceability analysis. For members in flexure, <math>H_f</math> was 1.3, an increase that matches the ratio of allowable stress decrease under the working stress method.</p> <p>The single load factor method is retained in the current EM for serviceability load combinations. Load combinations requiring serviceability level design are Usual and Unusual. The Usual case occurs frequently. The Unusual case is likely to occur during service life of the structure.</p>
3.2.1.1	Loads	<p>Usual, Unusual and Extreme load categories and the limits of AEP were selected to be consistent with other USACE design guidance. See 3.3.2.1 for discussion of loads and load factors.</p>
3.1.3	Strength Limit States	<p>The intention is for designs under the strength limit state to have uniform minimum design reliability. As the range and uncertainty in loads on hydraulic structures can vary greatly across load types and project locations, uniform reliability can only be achieved by using loads with very low likelihood of exceedance.</p>
3.1.4	Stability Analysis	<p>EM 1110-2100 provides criteria for stability of RCHS. <i>At the publishing time of this Engineer Manual, stability analyses of concrete structures is performed using limit equilibrium methods to compute a factor of safety. Therefore, stability analyses for all load cases must be performed both according to EM 1110-2-2100 to</i></p>

Section	Title	Comment(s)
		<p><i>check factors of safety for stability limit states, and according to (using) the load factor methods herein to compute moments and shears for structural design of members.</i> For load cases that include earthquake effects, the seismic coefficient used for stability may be different from what is used for strength analysis</p>
3.2.2	Load Definitions	<p>Loads and load combinations applicable to hydraulic structures are generally different from those provided for buildings in ACI-318 and ASCE-7. Therefore loads typically applied to RCHS were defined and developed for this manual.</p> <p>ASCE, AASHTO, and others have done much detailed work to define load types, load probability, and design loads for buildings and bridges. Comparatively little has been done for hydraulic structures. For most projects, hydraulic engineers have developed stage frequency relationships for hydrostatic loads. Wind and seismic information is available from ASCE, USGS, and other sources. For other loads, there is generally less information. Chapter 3 provides guidance based on information available at the time of development of this manual. General guidance is provided for loads for which little information is available. In many cases these loads will be site dependent:</p> <ul style="list-style-type: none"> <li>▪ <i>Load Combinations with Hydrostatic Forces.</i> For many hydraulic structures, hydrostatic forces from a pool are combined with other independent loads. Examples are wind driven waves on dam, thermal expansion ice loads on a dam, debris loads on a dam, wave loads on a floodwall, vessel impact forces, gate operation loads, and others. In some cases the hydrostatic loads may not be important, but the height of applied loads, determined by pool levels, may be. Studies for the Engineer Manual showed that pool levels to be combined with independent loads for the strength case must have low probability of exceedance. Reasons are similar to that presented in the comments on Section 3.5 (p F-13).</li> <li>▪ <i>Design Water Levels for Extreme Load Cases.</i> Load factors are intended to account for uncertainty in the nominal load and to provide adequate reliability. For lower nominal loads relative to possible loads, higher load factors are required. The predominant load on most RCHS is hydrostatic loading. The load is dependent on the differential head across the structure. The uncertainty of hydrostatic loading is highly site dependent. For this reason, nominal loads must be selected from the highest possible hydrostatic head. If the RCHS provides a higher level of protection than its authorized level of protection, the RCHS shall be designed to withstand the forces produced by water at the higher level of protection (for</li> </ul>

Section	Title	Comment(s)
		example, at the top of a wall) if life or significant economic losses initiate when the higher hydraulic events are experienced.
3.3.2.1	Minimum load factors for design of RCHS	<p><u>Usual and Unusual Loads</u></p> <p>An evaluation of design with load factors was performed to determine resulting service stresses in the concrete and reinforcing steel that will meet the performance requirement from Paragraph 3.2.1.2. A load factor of 2.2 was used for Usual loads, which is the same as the total single load factor (1.3 x 1.7) used in the previous version of the EM. Live load factors of 1.7 and 1.6 were evaluated for use with the Unusual load case. The load factor of 1.7 was often used in designs for Unusual load cases performed under the previous version of this manual, which was the load factor for live loads under ACI 318 until 2002. The load factor of 1.6 has been used with live load in ACI 318 since 2002.</p> <p>Comparisons are made with service limits stated in WES Technical Report SL-80-4 (Liu and Gleason 1981), i.e., with <math>f_c/f'_c &lt; 0.35</math> and <math>f_s/f_y &lt; 0.5</math>. A comparison is also made with maximum service stresses permitted in ACI 350-06. The allowable stress is computed as:</p> $f_{s,max} = \frac{260}{\beta \sqrt{s^2 + 4\left(2 + \frac{d_b}{2}\right)^2}} \quad \text{ACI 350, Equation (10-5)}$ <p>where:</p> <p style="margin-left: 40px;"><math>\beta</math> = Ratio of distances to the neutral axis from the extreme tension fiber and from the centroid of the main reinforcement.</p> <p style="margin-left: 40px;"><math>s</math> = Center-to-center spacing of deformed bars.</p> <p style="margin-left: 40px;"><math>d_b</math> = Diameter of bar.</p> <p>Table F-1-1 summarizes this comparison.</p>

Table F-1-1. Trial Serviceability Designs.

Load Category		Usual	Usual	Unusual	Unusual	Unusual	Unusual
Load Factor		2.2	2.2	1.7	1.7	1.6	1.6
Service Moment	kip-ft/ft	250	50	250	50	250	50
Factored Moment	kip-ft/ft	550	110	425	85	400	80
Design Section							
Required d (with $\rho = 0.25 \rho_b$ )	in	39.5	17.5	34.5	15.5	33.5	15
Required Reinforcing Area	In <sup>2</sup>	3.30	1.49	2.92	1.30	2.83	1.26
Cracking Moment	kip-ft/ft	150	35.5	117.0	29.0	110.9	27.5
Service Stresses							
Reinforcing Steel, $f_s$	ksi	25.4	25.3	33.2	32.9	35.0	35.0
$f_s/f_y$		0.42	0.42	0.55	0.55	0.58	0.58
Concrete, $f_c$	ksi	1.25	1.26	1.63	1.62	1.73	1.73
$f_c/f_c$		0.31	0.32	0.41	0.40	0.43	0.43
ACI 350 Allowable Stresses							
Allowable $f_s$ with $s = 12$ in.	ksi	21.0	18.8	20.5	18.4	20.4	18.2
	$f_s/f_y$	0.35	0.31	0.34	0.31	0.34	0.30
Allowable $f_s$ with $s = 6$ in.	ksi	34.8	31.7	34.1	31.1	34.0	30.9
	$f_s/f_y$	0.58	0.53	0.57	0.52	0.57	0.51
Common Parameters: Cover = 3 in. $\rho = 0.0071 = 0.25 \rho_b$ $f'_c = 4,000$ psi $f_y = 60,000$ psi Section width, $b = 12$ in.							

Section	Title	Comment(s)
		<p>The comparative designs summarized in Table F-1-1 show that the load factor of 2.2, with a value of <math>\rho &lt; 0.25\rho_b</math>, does meet the objectives of WES Technical Report SL-80-4 (Liu and Gleason 1981), i.e., of <math>f_c/f'_c &lt; 0.35</math> and <math>f_s/f_y &lt; 0.5</math>.</p> <p>The designs with live load factors of 1.7 or 1.6 for the Unusual load category show that <math>f_c/f'_c &lt; 0.45</math> and <math>f_s/f_y &lt; 0.6</math>. This indicates that the design will ensure that service stresses are well below crushing of the concrete and yield of the steel reinforcement, and that structural behavior is expected to be linear. The linear behavior will allow any tension cracks to close after the loading event has completed. For consistency with current ACI 318 and ASCE 7 codes, a load factor of 1.6 was selected.</p> <p><u>Limit States other than Flexure.</u> For limit states other than flexure, except for direct tension, the load factors developed for allowable flexural stresses are maintained. This will provide consistent design strength across components in a structure to ensure that more brittle failure modes do not prevail, that low stresses are maintained to limit concrete cracking, and that reliability is provided over long service lives.</p> <p><u>Strength Limit States</u></p> <p>Reliability-based load factors were developed for the strength limit states used with Extreme loads. General steps in developing load factors are:</p> <ol style="list-style-type: none"> <li>1. Review existing structures and identify loads.</li> <li>2. Compute reliability of the existing structures that were designed with previous engineer manuals.</li> <li>3. Establish reliability targets for new structures.</li> <li>4. Perform trial designs with trial load factors and load combinations.</li> <li>5. Calculate reliability of the trial designs.</li> <li>6. Adjust load factors and nominal loads and repeat steps 4 and 5 to achieve targets for reliability.</li> </ol> <p>In addition, load factors and target reliability in ASCE 7 were used as a guide.</p> <p><u>Reliability Analyses</u></p> <p>Before developing new sets of load factors for design of RCHS, it was important to understand the reliability of structures designed under previous guidance. Existing RCHS have performed very well</p>

Section	Title	Comment(s)									
		<p>from the standpoint of structural strength. Analyses were performed on existing inland and coastal floodwalls in three project sites designed from the 1960s to the 2000s. The existing structures had very low probabilities of load effects exceeding ACI 318 limit states for bending moment and shear (less than <math>10^{-6}</math> over a service life of 100 years). This showed that designs performed with previous guidance resulted in structures with very high reliability for concrete strength.</p> <p><u>Target Reliability</u></p> <p>Using reliability of existing RCHS and reliability targets provided in ASCE 7 as a guide, reliability targets for design expressed as <math>\beta</math> were determined for 100-yr project service lives as shown in Table F-1-2. The definition of Critical and Normal structures is provided in Chapter 3.</p> <p>where:</p> $\beta = E[SM]/\sigma[SM]$ <p><math>E[SM]</math> is the mean of the safety margin and <math>\sigma[SM]</math> is standard deviation of the safety margin. This can be rewritten as:</p> $\beta = E[C - Q]/(\sigma_C^2 + \sigma_D^2)^{1/2}$ <p>where C is the capacity and Q is the demand or load effect.</p> <p>Table F-1-2. Target Reliability for 100-yr Service Life, <math>\beta</math>.</p> <table border="1" data-bbox="634 1220 1344 1354"> <thead> <tr> <th></th> <th>Normal</th> <th>Critical</th> </tr> </thead> <tbody> <tr> <td>Redundant Load Path</td> <td>3.0</td> <td>3.5</td> </tr> <tr> <td>Single load Path</td> <td>3.5</td> <td>4.0</td> </tr> </tbody> </table> <p>Note that these targets are for the probability of a load occurring over the service life of the structure. They are not conditional upon a load occurring.</p> <p>Structures with single load paths (e.g.) have higher probability of collapse after reaching the limit state and therefore have higher targets for Beta and lower target probabilities of failure. Structures with redundant load paths can sustain more load and/or damage before collapse. Most RCHS are cantilever structures with single load paths. Therefore, load and load factor developed for RCHS are for structures with single load path.</p>		Normal	Critical	Redundant Load Path	3.0	3.5	Single load Path	3.5	4.0
	Normal	Critical									
Redundant Load Path	3.0	3.5									
Single load Path	3.5	4.0									

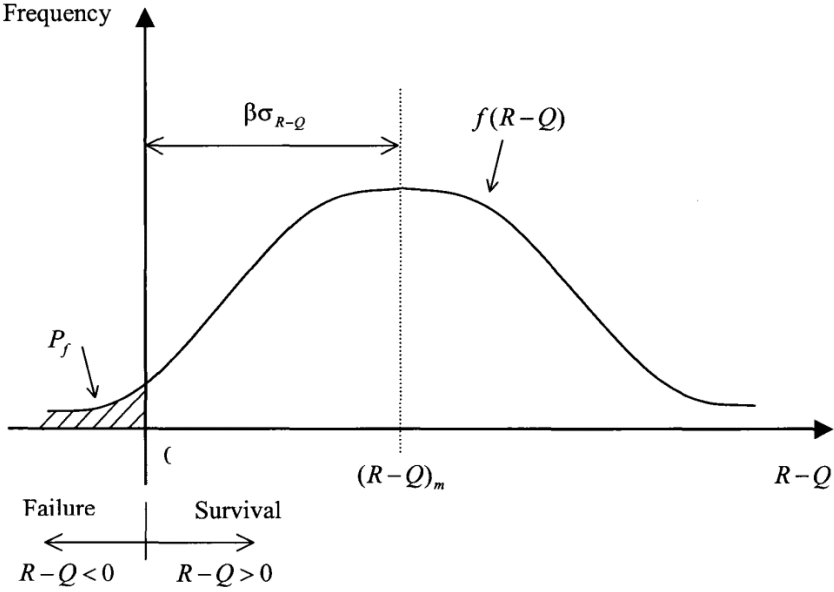
Section	Title	Comment(s)
		<p>From <math>\beta</math> the probability of failure (exceeding a specific limit state) <math>P_f</math> can be determined by:</p> $P_f \approx \Phi(-\beta)$ <p>where <math>\Phi</math> is the standard normal deviate.</p> <p>For the load factor calibration that was performed, the <math>P_f</math> was computed using Monte Carlo simulation and <math>\beta</math> then computed from <math>P_f</math>. See Figure F-1-1 for an illustration of these concepts.</p>  <p>Figure F-1-1. Reliability Concepts.</p> <p><u>Calibration.</u> Calibration was performed for loads designed at the minimum for the following structures and load types:</p> <ol style="list-style-type: none"> <li>1. <i>Inland Floodwall.</i> Trial designs for soil-founded floodwalls on the Red River of the North at Grand Forks, ND and at Pembina, ND. The design water surface was at the top of the wall, which was considered the maximum possible hydrostatic loading condition before inundation of the protected side.</li> <li>2. <i>Coastal Floodwall.</i> Cantilever floodwall stem subject to surge and wave with no tailwater. The example section was in Freeport, TX for which distributions of annual frequency vs. wave and surge loads had been developed by ERDC-CHL.</li> <li>3. Earth retaining wall with no water present.</li> <li>4. Vessel impact on a navigation approach wall with no other lateral loads (hydrostatic or earth pressures) present.</li> <li>5. Wave plus independent hydrostatic loads on cantilever wall stems on Big Bend and Fort Randall dams, SD.</li> <li>6.</li> </ol>



Section	Title	Comment(s)
		<p><u>Extreme Loads.</u></p> <p>ASCE 7 has been moving to the principle of Uniform Risk (uniform reliability) for establishing nominal loads and load factors, rather than Uniform Hazard as had been used previously. Under the Uniform Risk principle in ASCE 7, loads and load factors are chosen to provide uniform reliability for structures with a given risk category. To obtain this, nominal loads are selected with low probability of exceedance (large return period), and a load factor of 1.0 is used. Nominal loads for Extreme load cases/strength limit states for RCHS are intended to be determined similarly.</p> <p>Minimum return periods for design of RCHS structures were determined by calculation and comparison with ASCE 7-16 design for wind forces. Design for wind load in ASCE 7 is based on an extreme value distribution of maximum annual wind velocities. Most temporary and dynamic loads on RCHS are expected to have a similar distribution of annual maximums. The return period of 3,000 years for design wind velocities in ASCE 7-16 is intended to provide a structure with reliability, <math>\beta</math>, of 3.5 in 50 years. This was considered adequate for normal RCHS structures with a single load path. A return period of 10,000 years for design of critical structures will provide a corresponding <math>\beta</math> of approximately 4.0, which sufficiently meets reliability targets. A load factor of 1.0 is used when nominal loads are selected at these return periods.</p> <p>For structures in which the design return periods in the previous paragraph are not possible due to geometry or other constraints, the design return periods stated obviously cannot be used for design. For these structures the maximum possible load must be used for design. With design load return periods potentially at the lower limits shown in Figure 3-1, load factors are required to provide adequate reliability. A load factor of 1.3 was found to meet reliability targets for floodwalls with maximum differential head at a 300-year return period for normal structure and at a 750-year return period for critical structures. Based on this analysis, the load factor of 1.3 was adopted for all loads potentially limited to return periods at the lower end of the limits for Extreme loads.</p> <p>For many loads on hydraulic structures, such as debris impact, thermal expansion ice force, equipment loads, and hydrodynamic forces, insufficient data exists from actual events to determine return periods of loading. Design is performed with loads considered upper bounds of possible loading. Because of the uncertainty in the actual loading, a load factor of 1.3 is applied. This load factor was chosen based on past experience, and to maintain consistency with the load factor developed in the previous</p>

Section	Title	Comment(s)
		<p>paragraph.</p> <p><u>Load Factors for Soil Pressures.</u> Strength limit state load factors for soil vertical and lateral loads were derived from AASHTO LRFD Bridge Design Specifications 2014, 7<sup>th</sup> ed. Work has been performed by and in support of AASHTO to determine appropriate load factors for soil. No new work was performed for this Engineer Manual.</p> <p><u>Critical and Normal Structures</u></p> <p>For simplicity and consistency with EM 1110-2-2100, required reliability for critical and normal structures is accounted for by the minimum annual probability of the exceedance used to define the strength limit state/Extreme load case. The load factor applied to both critical and normal structures is the same. Serviceability requirements for critical and normal structures are also the same.</p> <p><u>Members in Direct Tension</u></p> <p>In the previous edition of EM 1110-2-2104, the hydraulic load factor, <math>H_f</math>, was increased from 1.3 to 1.65 for members in direct tension. This was directly related to the historically lower allowable stress for direct tension members in the Allowable Stress Design code. The reason for increasing the load factor or decreasing the allowable stress for members in direct tension is to reduce the potential for crack propagation. Due to the difficulty in predicting crack propagation, this simpler approach of increasing the hydraulic factor coupled with successful experience led to the factor of 1.65. For the present manual, the load factors for direct tension were derived from the factors developed using Table F-1-1. These factors are computed by <math>2.2 \times 1.65 / 1.3 = 2.8</math> for the Usual load category and <math>1.6 \times 1.65 / 1.3 = 2.0</math> for the Unusual load category. No additional factor is provided for the Extreme load categories because the performance requirements are based on the ultimate strength of the member, not control of cracking.</p>
3.3.3	Earthquake Load (effects)	
3.3.3.1		No Comments
3.3.3.2		<p><u>Earthquake Definitions</u></p> <p>From ER 1110-2-1806, some design earthquake definitions and estimating ground motions are:</p> <ul style="list-style-type: none"> <li>▪ <i>Maximum Credible Earthquake (MCE).</i> An MCE is defined as the largest earthquake that can reasonably be expected to be</li> </ul>

Section	Title	Comment(s)
		<p>generated by a specific source on the basis of seismological and geological evidence. Since a project site may be affected by earthquakes generated by various sources, each with its own fault mechanism, maximum earthquake magnitude, and distance from the site, multiple MCEs may be defined for the site, each with its own characteristic ground motion parameters and spectral shape. The MCE is evaluated using Deterministic Seismic Hazard Analysis (DSHA) methods informed by results from a PSHA. Since different sources may result in differing spectral characteristics, selection of “maximum” ground motion parameters may need to consider different sources and magnitude events to consider the full range of possible maximum loadings e.g., peak ground acceleration from one source may be higher than from another, but reversed for 1s spectral acceleration values. Therefore, both sources may need to be considered in the analysis to assess the full range of potential “maximum” loadings. There is no return period for the MCE.</p> <ul style="list-style-type: none"> <li data-bbox="581 919 1422 1608">▪ <i>Maximum Design Earthquake (MDE)</i>. The MDE is the maximum level of ground motion for which a structure is designed or evaluated. The associated performance requirement is that the project performs without loss of life or catastrophic failure such as an uncontrolled release of a reservoir, although severe damage or economic loss may be tolerated. For critical features, the MDE is the same as the MCE. For all other features, the minimum MDE is an event with a 10% probability of exceedance in 100 years (average return period of 950 years) assessed using a PSHA informed by the results of a site specific DSHA. A shorter or longer return period for non-critical features can be justified by the project team based on the Hazard Potential Classification for Civil Works Projects in Appendix B, Table B-1 of ER 1110-2-1806. A project with a low hazard potential classification may consider return periods less than 950 years, while projects with a significant or high hazard potential classification may consider longer return periods. The MDE can be characterized as a deterministic or probabilistic event.</li> <li data-bbox="581 1608 1422 1902">▪ <i>Operating Basis Earthquake (OBE)</i>. The OBE is an earthquake that can reasonably be expected to occur within the service life of the project, typically a 50% probability of exceedance in 100 years (average return period of 144 years) assessed using a PSHA informed by the results of a site specific DSHA. The associated performance requirement is that the project functions with little or no damage and without interruption of function. The purpose of the OBE is to protect</li> </ul>

Section	Title	Comment(s)
		<p>against economic losses from damage or loss of service. Therefore, the OBE is a serviceability load case. Alternative choices of return periods for the OBE may be based on economic considerations.</p> <ul style="list-style-type: none"> <li>▪ <i>Estimating OBE and MDE Ground Motions.</i> Estimates are usually made in two phases. The first estimates are used as a starting point for the study and shall be obtained from USGS spectral acceleration maps. EM 1110-2-6053 (Appendices B and C) describes the method to develop standard response spectra and EPGA for the required probability of exceedance (return period) for OBE and MDE. Site specific studies in accordance with Paragraph 6g(2) are often required for selecting the final estimates of OBE and MDE ground motions. Both DSHA and PSHA approaches are appropriate. Combining the results of deterministic and probabilistic analyses is often an effective approach for selecting MDE ground motions. Typical results of a probabilistic analysis are a hazard curve and an equal hazard spectrum, both of which relate the level of ground motion to an annual frequency of exceedance or return period. This information can be used to complement the deterministic analysis by removing from consideration seismic sources that appear unreasonable because of low frequencies of occurrence by justifying median or median-plus-standard deviation estimates of deterministic ground motion or by ensuring consistency of MDE ground motions with a performance goal. <p><u>Load Factors for MDE and MCE.</u></p> <p>A reliability-based calibration of the load factors for earthquake was not performed for this version of EM. The basis for the load factors is described in the following paragraphs:</p> <p>Different load factors are generated depending on whether site specific and standard procedures are used. The techniques used to generate site specific earthquakes are assumed to produce more reliable (i.e., they result in less variability) earthquakes, which produces a lower load factor. The standard (non-site specific) earthquakes are based on a generalization of the earthquake potential within the region, and they are considered less reliable (i.e., they result in more variability) than a site specific generated earthquake. Therefore, they will have higher load factors to reflect this increased variability:</p> <ul style="list-style-type: none"> <li>▪ <i>Standard Ground Motion Analysis.</i> The reduction in the load</li> </ul> </li></ul>

Section	Title	Comment(s)
		<p>factors for the dead and live loads is due to the unlikely probability of the maximum dead and live loads occurring with the earthquake events. The higher load factor for the earthquake load is a direct result of the high variability (uncertainty) in this standard earthquake load. This uncertainty is a function of the nature of earthquakes coupled with the development and use of seismic coefficients without regards to site specific seismic characteristics. The standard seismic studies and ground motions can be obtained from published U.S. Geological Survey (USGS) spectral acceleration maps. The method to develop standard response spectra and EPGA for desired return periods for OBE and MDE at the project site is described in EM 1110-2-6053.</p> <ul style="list-style-type: none"> <li>▪ <i>Site Specific Ground Motion.</i> The earthquake load factor is reduced due to the determination of a site specific earthquake that incorporates the potential sites and local attenuation characteristics in the earthquake load. Performing a site specific seismic analysis to define a site specific response spectrum or time history reduces the variability in the seismic load and therefore reduces the seismic load factor. The site specific seismic studies and ground motions with respect to the development of site specific, design response spectra can be found in EM 1110-2-6050 and, with respect to the development of site specific time histories, in EM 1110-2-6051.</li> </ul>
3.5	Reinforcement Limits	
3.5.1.4		The minimum tension reinforcement ensures that the strength limit state is a ductile failure mode that exceeds the cracking moment as estimated from its modulus of rupture.

APPENDIX G

Acronyms and Abbreviations

Term	Definition
AASHTO	American Association of State Highway and Transportation Officials
ACI	American Concrete Institute
AREMA	American Railway Engineering and Maintenance-of-Way Association
ASCE	American Society of Civil Engineers
ASTM	American Society for Testing and Materials
AWS	American Welding Society
BI	Barge Impact
CASE	Computer-Aided Software Engineering
CECW	Directorate of Civil Works, US Army Corps of Engineers
D	Dead Load
CGSI	Concrete General Strength Investigation
DSHA	Deterministic Seismic Hazard Analysis
EM	Engineer Manual
EPGA	Effective Peak Ground Acceleration
EQ	Earthquake Load
ER	Engineer Regulation
EH	Horizontal Earth
ES	Earth Surchare
EV	Vertical Earth
G	Non Permanent Gravity Loads
HA	Hawser
Hs	Hydrostatic
Hd	Hydrodynamic
Hw	Wave
HQUSACE	Headquarters, U.S. Army Corps of Engineers
IM	Impact
IX	Thermal Expansion of Ice
L	Live Load

Term	Definition
Ld	Dynamic Loads
Lp	Permanent Loads
LRFD	Load and Resistance Factor Design
Lt	Temporary (Variable or Intermittent Static) Loads
MCE	Maximum Credible Earthquake
MDE	Maximum Design Earthquake
NA	Not Applicable
NISA	Nonlinear Incremental Structural Analysis
OBE	Operating Basis Earthquake
Q	Operating Equipment
RCHS	Reinforced Concrete Hydraulic Structures
T	Self Straining Forces
$t_r$	Return Period
UFGS	Unified Facilities Guide Specification
USACE	U.S. Army Corps of Engineers
USGS	U.S. Geological Survey
V	Vehicle
W	Wind